

MaxShine®
Private Label



IN PURSUIT OF AUTOMOTIVE PERFECTION
SINCE 2006

NO. 2026/2027

MAXSHINE HQ

📍 3rd. Floor, 1# Building, No. 1 Fuyuan Road Jiujiang EDZ, Wuhu, 241000 China

☎ +86 553 3932 199 ; +86 553 4996 266

🌐 www.maxshinechina.com

✉ sales@maxshinechina.com

About Maxshine

For over 20 years, Maxshine has been a leading manufacturer specializing in long-throw dual action polishers and premium auto detailing products. Today, our brand is recognized in more than 50 countries and regions worldwide as one of the most trusted names in car care.

Our rapid global growth stems from an unwavering passion and dedication to the art of detailing. Innovation has always been at the core of our development, driving us to integrate the latest technology and deliver products that elevate the detailing experience.

At Maxshine, we are committed to providing high-quality products paired with exceptional customer service. From the moment of purchase to our comprehensive after-sales support, we ensure every customer enjoys a seamless and satisfying experience. Designed with high-grade materials, precision engineering, and a clean, functional style, Maxshine products bring excellence and reliability to every detailer's toolkit.

In recent years, we have expanded our capabilities through strategic partnerships, including joint ventures with suppliers in China to enhance quality control and innovation in categories. These collaborations reflect our commitment to continuous improvement and to offering the most cost-effective, high-performance solutions for professional and enthusiast detailers alike.

Looking ahead, Maxshine will continue to innovate, grow, and set higher standards in the detailing industry. Our promise is simple: we will never stop progressing, never stop improving, and never stop fueling the passion for detailing worldwide.

Maxshine – All For Detailing

*Maxshine
Team*





- | | | | | |
|--------------|-----------------|--------------------|---------------|--------------------|
| 1 AMERICA | 16 JAPAN | 31 SWEDEN | 46 IRAN | 61 THE PHILIPPINES |
| 2 ARGENTINA | 17 MEXICO | 32 SINGAPORE | 47 LITHUANIA | 62 GIBRALTAR |
| 3 AUSTRALIA | 18 MAURITIUS | 33 TAIWAN | 48 KAZAKHSTAN | 63 TRINIDAD |
| 4 BRAZIL | 19 MALAYSIA | 34 THE NETHERLANDS | 49 QATAR | 64 ALGERIA |
| 5 BRUNEI | 20 NORWAY | 35 TURKEY | 50 COSTA RICA | 65 PANAMA |
| 6 BELGIUM | 21 NEW ZEALAND | 36 THAILAND | 51 REUNION | 66 LEBANON |
| 7 CANADA | 22 PAKISTAN | 37 THE MIDDLE EAST | 52 BOLIVIA | 67 EGYPT |
| 8 DENMARK | 23 POLAND | 38 UNTIED KINGDOM | 53 CYPRUS | 68 UZBEKISTAN |
| 9 FRANCE | 24 PORTUGAL | 39 VIETNAM | 54 IRAQ | 69 PARAGUAY |
| 10 FINLAND | 25 PERU | 40 CAMBODIA | 55 SRI LANKA | 70 SERBIA |
| 11 GERMANY | 26 RUSSIA | 41 COLOMBIA | 56 MYANMAR | 71 UKRAINE |
| 12 GREECE | 27 SOUTH KOREA | 42 PUERTO RICO | 57 BAHRAIN | 72 KUWAIT |
| 13 INDONESIA | 28 SPAIN | 43 SAUDI ARABIA | 58 ISRAEL | 73 KOSOVO |
| 14 INDIA | 29 SOUTH AFRICA | 44 CHILE | 59 SLOVENIA | |
| 15 ITALY | 30 SWITZERLAND | 45 IRELAND | 60 URUGUAY | |

*One Of The Most Popular Auto Detailing Brands In More Than 100 Countries
And Regions Around The World*





CONTENT

02	• ABOUT MAXSHINE	59	• PREMIUM MICROFIBER WASH MITT	97	• WOOL POLISHING PAD	175	• DETAILING SPRAYER
07	• DUAL ACTION POLISHER	69	• PREMIUM MICROFIBER WASH PAD	109	• DETAILING BRUSH	177	• DETAILING TOOL BAG
21	• ROTARY POLISHER	75	• SHEEPSKIN NATURAL WASH MITT	139	• PREMIUM CAR DUSTER	187	• FOAM WAXING APPLICATOR
35	• PLATE BACKING PAD	81	• SCRUB NINJA SPONGE	147	• CLAY PRODUCTS SERIES	197	• DETAILING ACCESSORIES
39	• PREMIUM MICROFIBER TOWEL	85	• FOAM POLISHING PAD	155	• SNOW FOAM LANCE	219	• CAR DRYER
		93	• PREMIUM MICROFIBER DA PAD	167	• TORNADOR CLEANING GUN	225	• MULTI-FUNCTIONAL HOLDER

DUAL ACTION POLISHER









Dual Action Polishers Help You Make Vehicles Clean And Shining!
Dual Action Polishers Help You Make Car Detailing
Safer and Easier!
Fast, Effective, Safe and Easy-to-Use!
Swirl-free, Professional Results with No Risk!
Easily Remove Swirl Marks and Scratches,
and Improve Paint Gloss!



1000W DUAL ACTION POLISHER

M6 SERIES



<p>CNC Steel Counterweight</p> <p>High-Precision CNC Parts Well-balanced for smooth polishing</p> 	<p>Premium Core Intelligent Protection & Care</p> <p>Soft Start: Prevent polish splash, increase safety and extend the service life of switch, motor and gears. Constant Speed: Maintain constant speed output however the load changes.</p> 	<p>Better Operation</p> <p>Vibration Inhibition Technology Easy to control, beginner friendly.</p> 
<p>Air Vents</p> <p>Optimized internal ventilation Structure for better heat dissipation</p> 	<p>6-level Stepless Speed Setting</p> <p>Control with big button 2200-5000 OPM To meet various working conditions</p> 	<p>Cooling Passages Design</p> <p>Dust devil multi-hole backing plate</p> 

ITEM NO.: M6 SERIES						
ITEM NO.	Disc Size	Orbit	Rated Voltage	Input	Spindle Thead	No Load Speed
M6-8	125mm,5"	8mm	110-240V AC	1000W/9A	5/16"-24	2500-6500/min
M6-12	125mm,5"	12mm	110-240V AC	1000W/9A	5/16"-24	2200-5000/min
M6-15	125mm,5"	15mm	110-240V AC	1000W/9A	5/16"-24	2200-5000/min
M6-21	150mm,6"	21mm	110-240V AC	1000W/9A	5/16"-24	2200-5000/min

PU Velcro Backing Plate,D Handle,Wrench,Carbon Brush,Manual.



550W DUAL ACTION POLISHER

M3 SERIES



CNC Steel Counterweight
High-Precision CNC Parts
Well-balanced for smooth polishing



Trigger Lock
Lock the switch so that the machine can keep running



Air Vents
Optimized internal ventilation
Structure for better heat dissipation



6-level Stepless Speed Setting
Control with big button 2000-5500 OPM
To meet various working conditions

ITEM NO.: M3-12	
Dice Size: 75mm,3-3.5"	Input: 550W/5A
Orbit Diameter Size: 12mm	Spindle Thread: 5/16"-24
Rated Voltage: 110-240V AC	No Load Speed: 2000-5500/min
PU Velcro Backing Plate,D Handle,Wrench,Carbon Brush,Manual.	

1100W DA POLISHER

ITEM NO.	Disc Size	Orbit	No Load Speed
FDA8	150mm, 6"	8mm	160 - 480rpm

Input: 1100w Rated Voltage: 110-240V AC
Polishing Backing pad: 150mm
Supplied with a D-Handle, Spare Set of Brushes & Spanner,
Manual, Color box.



1100W DA POLISHER

ITEM NO.	Disc Size	Orbit	No Load Speed
FDA8-V2	25mm, 6"	8mm	160 - 480rpm

Input: 1100w Rated Voltage: 110-240V AC
Polishing Backing pad: 125mm
Supplied with a D-Handle, Spare Set of Brushes & Spanner,
Manual, Color box.



FDA8 SERIES





8MM ORBIT DUAL ACTION POLISHER

DA 1000



Zinc Alloy Counterweight

High Strength Zinc Alloy Counterweight wear-resistant, corrosion-resistant for smooth polishing.



Ergonomic Design

Soft Grip Hood
The soft grip hood absorb vibration and enhance control force.

Soft Support Bar
Stable placement, protect the car paint.



Better Operation

Vibration Inhibition Technology
Easy to control, beginner friendly.



Air Vents

Optimized internal ventilation
Structure for better heat dissipation



6-level Stepless Speed Setting

Control with dial 2500-6500 OPM
To meet various working conditions

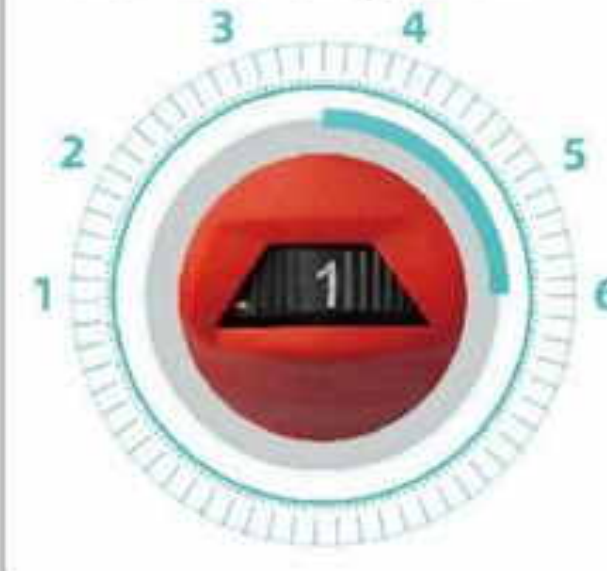

Cooling Passages Design

Dust devil multi-hole
backing plate



ITEM NO.: DA1000

Rated Voltage: 110V - 240V AC	Velcro Backing Plate Size: 125mm (5")
Orbit Diameter Size: 8mm	Rated Power: 1000W
Frequency: 60Hz / 50Hz	Polishing Pad Size: 125mm (5")
Thread Size: 5/16"-24	Variable Speed: 2,500 - 6,500 OPM
Rated Current: 9Amp.	Net Weight: 2.3kgs (4.8Lbs)
Power Cord 4.0 meters EU/US	
Accessory: PU Velcro Backing Plate,D Handle,Wrench,Carbon Brush,Manual	



BRUSHLESS DUAL ACTION POLISHER

BL PRO SERIES



Accelerator Trigger

Trigger with auto speed adjustment - accelerates with pressing depth.



Ergonomic Design

Soft Grip Hood
The soft grip hood absorb vibration and enhance control force.

Soft Support Bar
Stable placement, protect the car paint.



Better Operation

Vibration Inhibition Technology
Easy to control, beginner friendly.



Air Vents

Optimized internal ventilation
Structure for better heat dissipation



6-level Stepless Speed Setting

Control with dial 2200-5200 OPM
To meet various working conditions



Brushless Motor

No carbon brushes to replace. Brushless motor reduces maintenance and extends polisher lifespan. saving time and money



ITEM NO.: BL PRO SERIES							
ITEM NO.	Disc Size	Orbit	Rated Voltage	Input	Spindle Thread	No Load Speed	Counterweight
BL8 Pro	125mm, 5"	8mm	110-240V AC	1200W	5/16"-24	2200-6500 OPM	Zinc Alloy Counterweight
BL15 Pro	125mm, 5"	15mm	110-240V AC	1200W	5/16"-24	2200-5200 OPM	CNC Steel Counterweight
BL21 Pro	150mm, 6"	21mm	110-240V AC	1200W	5/16"-24	2200-5200 OPM	CNC Steel Counterweight
20ft/6m 360-degree Swivel Cable US/EU							

ROTARY POLISHER

Electronic Switch Maintains Constant Speed under Load. Heavy-Duty Motor Provides High Power.
Setting with 6-Speed Control
Comfortable Non-Slip Grip D Handle.
High Impact Housing with Die Cast Aluminum Head.
Sealed 100% Ball-Bearing Construction Provides Longer Life.
Warranty: 1 year warranty against defects in materials or workmanship.



1200W BRUSHLESS ROTARY POLISHER

BL1200 PRO



Ergonomic Design
The soft grip hood absorb vibration and enhance control force.



Accelerator Trigger
Trigger with auto speed adjustment - accelerates with pressing depth.



Air Vents
Optimized internal ventilation Structure for better heat dissipation

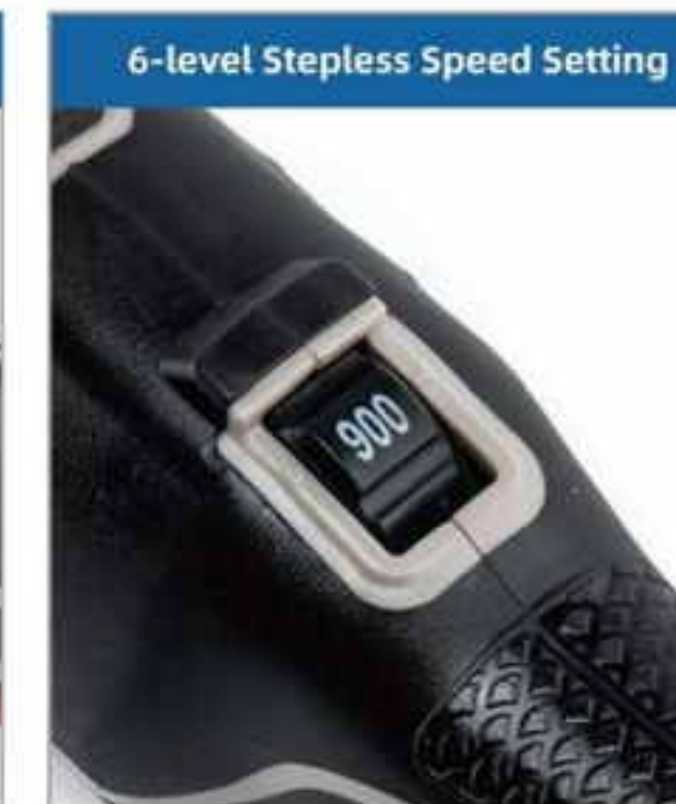

6-level Stepless Speed Setting
Control with big button 700-3200 RPM To meet various working conditions



Brushless Motor Polisher
The brushless motor is powerful and has low noise.No spark hazard,don't need replace carbon brushe & rotor to save time and costs.

ITEM NO.: BL1200 Pro	
Rated Voltage: 110-240V AC	Input: 1200W
Spindle Thread: 5/8" or M14	No load speed: 900-3200 RPM
Disc Size: 125mm/5" 150mm/6"	
20ft/6m 360-degree Swivel Cable	



550W ROTARY POLISHER

M3 RP550

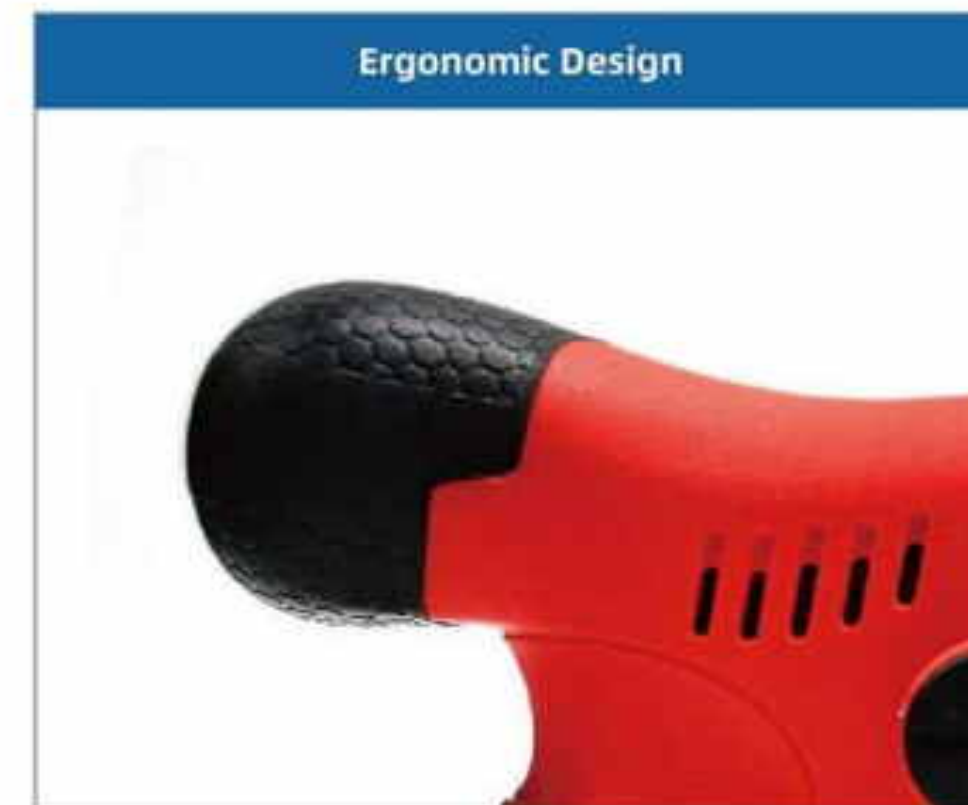

Ergonomic Design
Soft Grip Hood
The soft grip hood absorb vibration and enhance control force.



Trigger Lock
Lock the switch so that the machine can keep running



Air Vents
Optimized internal ventilation
Structure for better heat dissipation



6-level Stepless Speed Setting
Control with big button 1000-3500 RPM
To meet various working conditions

ITEM NO.: M3 RP550	
Rated Voltage: 110-240V AC	Input: 550W
Spindle Thread: 5/8" or M14	No load speed: 1000-3500/min
Disc Size: 75mm,3-3.5"	Net Weight: 3.2kgs
Velcro Backing Plate,Side Handle,Wrench,Carbon Brush,Manual.	

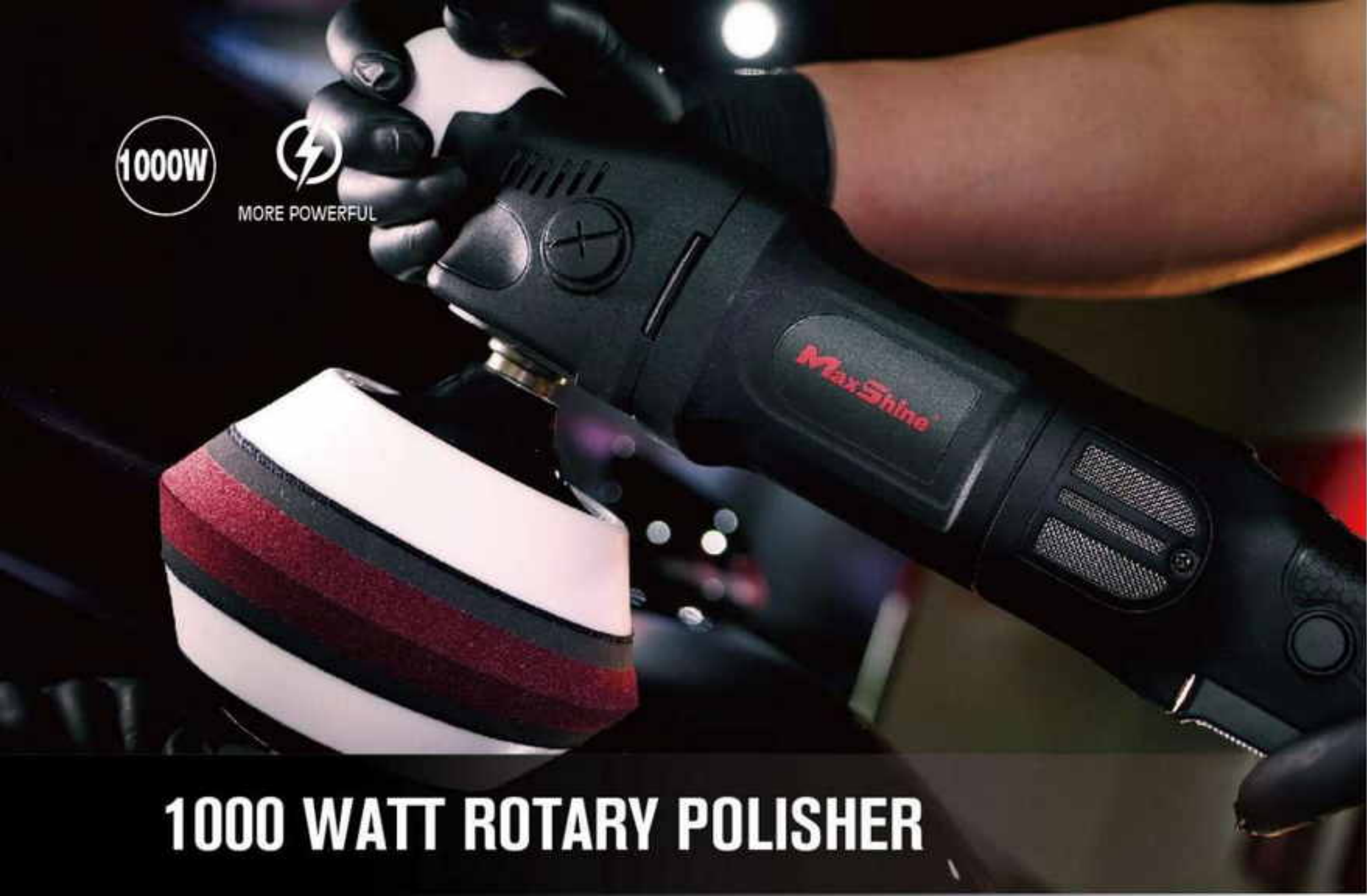

1000 WATT ROTARY POLISHER

M6 RP1000



Ergonomic Design



Soft Grip Hood
The soft grip hood absorb vibration and enhance control force.

Premium Core Intelligent Protection & Care



Soft Start
Prevent polish splash, increase safety and extend the service life of switch, motor and gears..

Air Vents



Optimized internal ventilation
Structure for better heat dissipation

6-level Stepless Speed Setting

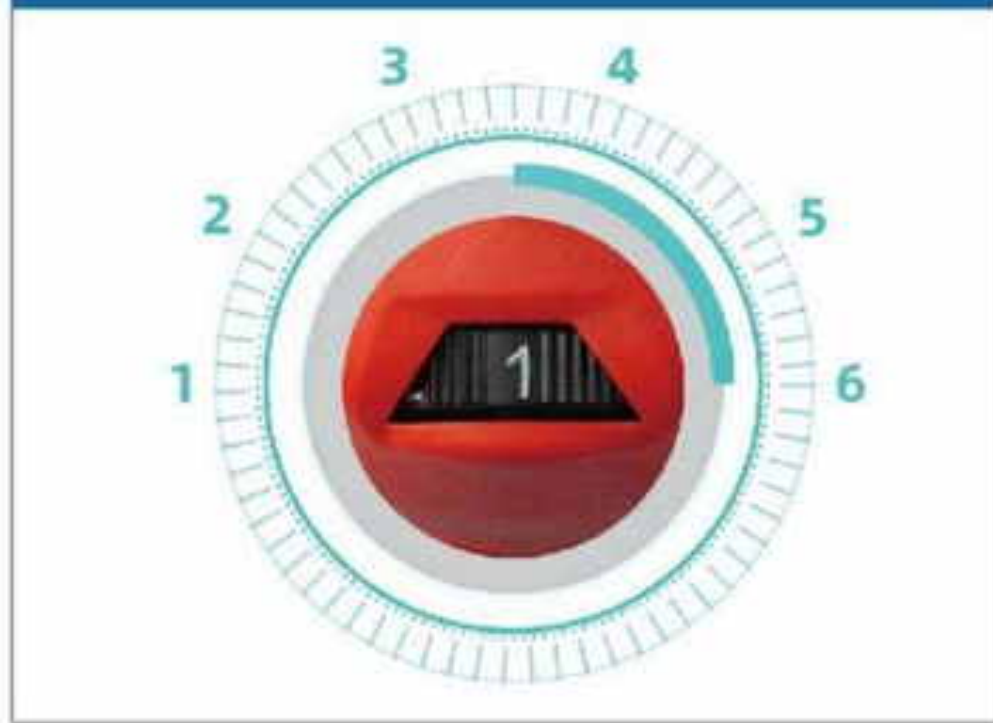

Control with big button 800-3300 RPM
To meet various working conditions

ITEM NO.: M6 RP1000

Rated Voltage: 110-240V AC	Input: 1000W
Spindle Thread: 5/8" or M14	No load speed: 800-3300/min
Disc Size: 125mm, 5"	Net Weight: 3.2kgs
Velcro Backing Plate, Side Handle, Wrench, Carbon Brush, Manual.	

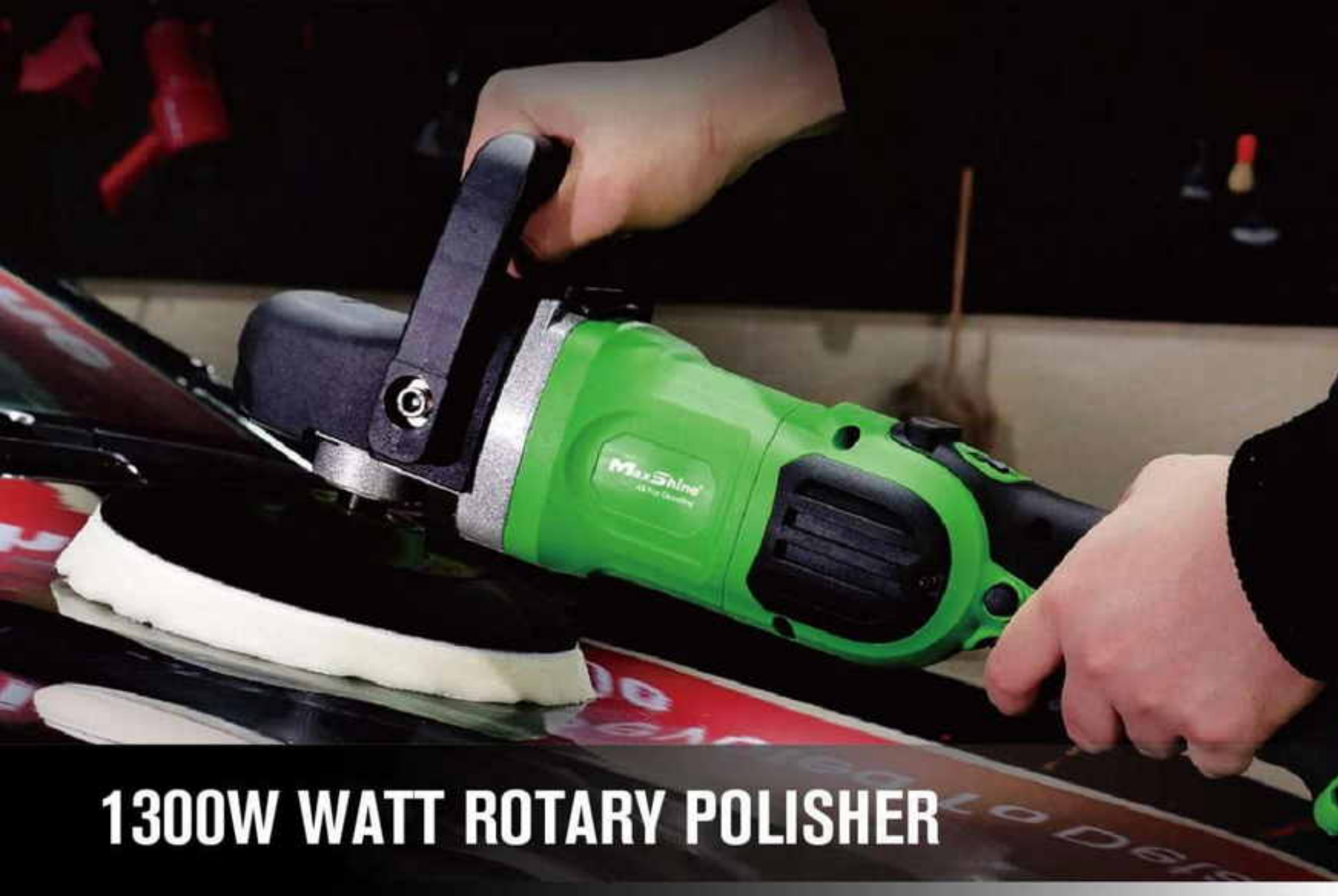

1300W WATT ROTARY POLISHER

RP1300



Ergonomic Design



Soft Grip Hood
The soft grip hood absorb vibration and enhance control force.

Premium Core Intelligent Protection & Care



Soft start with constant Power system
setting with 6 Speed control

Air Vents



Optimized internal ventilation
Structure for better heat dissipation

6-level Stepless Speed Setting

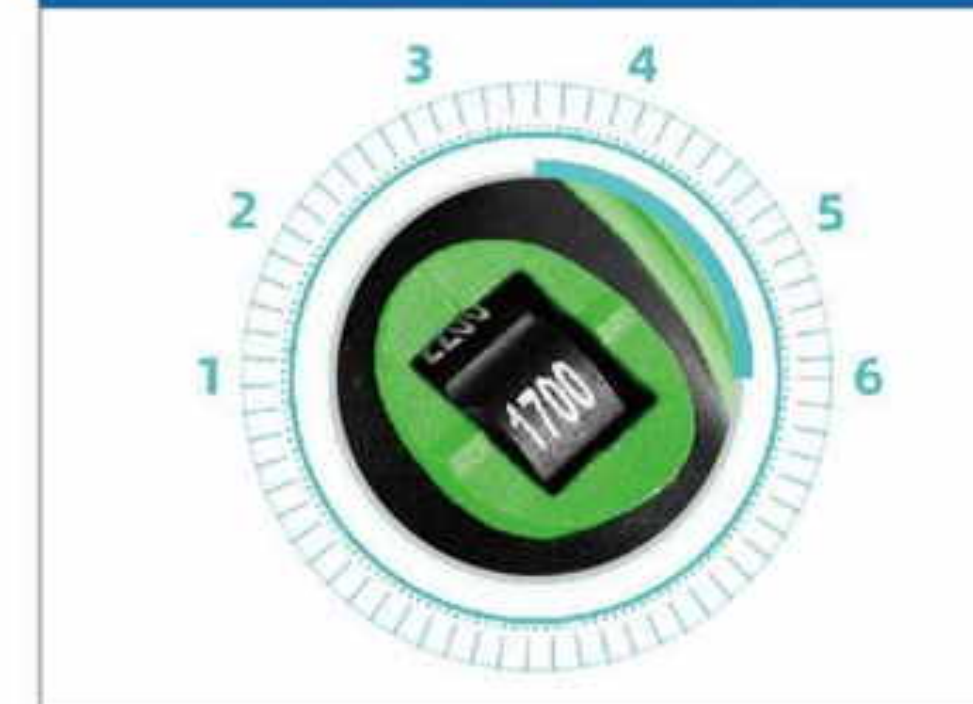

Control with big button 600-3200 RPM
To meet various working conditions

ITEM NO.: RP1300

Rated Voltage: 110-240V AC	Input: 1300W
No Load Speed: 600-3200 RPM	Disc Size: 178mm/7"
Spindle Thread: 5/8" or M14	
Dimensions and weight: 19.69in (L) x 8.27in (W) x 6.3in (H), 7.28lbs	
Package including: PU Hook & Loop Backing Plate, Wool Hood, Wrench, Carbon Brush, Manual, D Handle, Side Handle.	



MINI CORDLESS POLISHER V2

PACKAGE INCLUDING:



MS-MP0312 V2

Features:
 Lightweight and compact
 Dual Action and Rotary capability
 1.5" & 2" backing plates included,
 as well as rotary extension bars
 2 battery packs provide continuous use

Specifications:
 80W Mini Cordless Polisher
 Rotary, 3mm, 12mm orbit DA polisher
 6 Speed Settings (2000-4700RPM)
 Digital Screen for battery life
 2 Batteries (2.0Ah)
 1.5" and 2" Backing Plates
 Extension Bars Included

Included Polishing Pads:
 5x 1.5" Yellow Polishing Pads
 5x 1.5" Red Finishing Pads
 5x 1.5" Wool Cutting Pads
 5x 1.5" Blue Microfiber Pads
 5x 2" Yellow Polishing Pads
 5x 2" Red Finishing Pads
 5x 2" Wool Cutting Pads
 5x 2" Blue Microfiber Pads

BASIC INSTRUCTIONS



Insert wrench into output shaft, then rotate eccentricity seat to install the entire eccentric part as shown in figure 1.



Then install protection cover as shown in figure 2.



Insert wrench into flat square shaft, and then rotate polishing pad. This way you can easily install all the polishing heads.



Battery Pack Button

Warning:
 Be sure to disconnect the power when installing or replacing the polishing head.



MINI POLISHING SYSTEM



MS-MN01

Cable: 1.5m Thread: M14 or 5/8"

The MN01 is designed to be used in tight areas like car headlamps, fog lights, brake lights, door handles, emblems, glass, interior console panels and other small areas.

The universal locking mechanism makes it extremely easy to lock-in all of your favorite accessories. Specifically designed for polishing small areas, the MN01 is proficient in gently removing debris, scratches and other surface imperfections on the recessed areas of your vehicles.

A variety of mini-custom accessories is included that allows you to work on different surfaces. It comes equipped to connect to a 5/8" or M14 connector - which are the industry standard outputs for rotary polishers.



Including	Red Finishing Pad	Green Polishing Pad	Felt Polishing Pad	Long Wool Pad	Orange Polishing Pad
	∅1.5x1cm(3pc) ∅2.6x1.2cm(3pc)	∅1.5x1cm(3pc) ∅2.6x1.2cm(3pc)	∅1.5x0.5cm(3pc)	∅2.5cm(3pc)	Size: 3x4.5cm(3pc)
	Orange Polishing Pad	Backing Pad	Adaptor M14 or 5/8"	Small Wrench	Small Bag
	Size: 3x3cm(3pc)	∅1.5cm(1pc) ∅2.5cm(1pc)	1pc	1pc	1pc
	Polishing Machine, Rubber 1.5m				

BACKING PLATES

Distributes pressure evenly for optimum defect removal with a high-speed DA polisher

10mm thickness of the Polyurethane provides durability from heat and pressure.

The flexible backing plate is ideal for all brands of Dual Action polishing machines with a 5/16" diameter thread.

The hook and loop backing plate grips all pad types, ensuring pads stay centered and balanced.

The vented design offers fresh air to help cool the backing plate and extend durability.

It can be used more than 10,000 times.



DA PLATE BACKING PAD

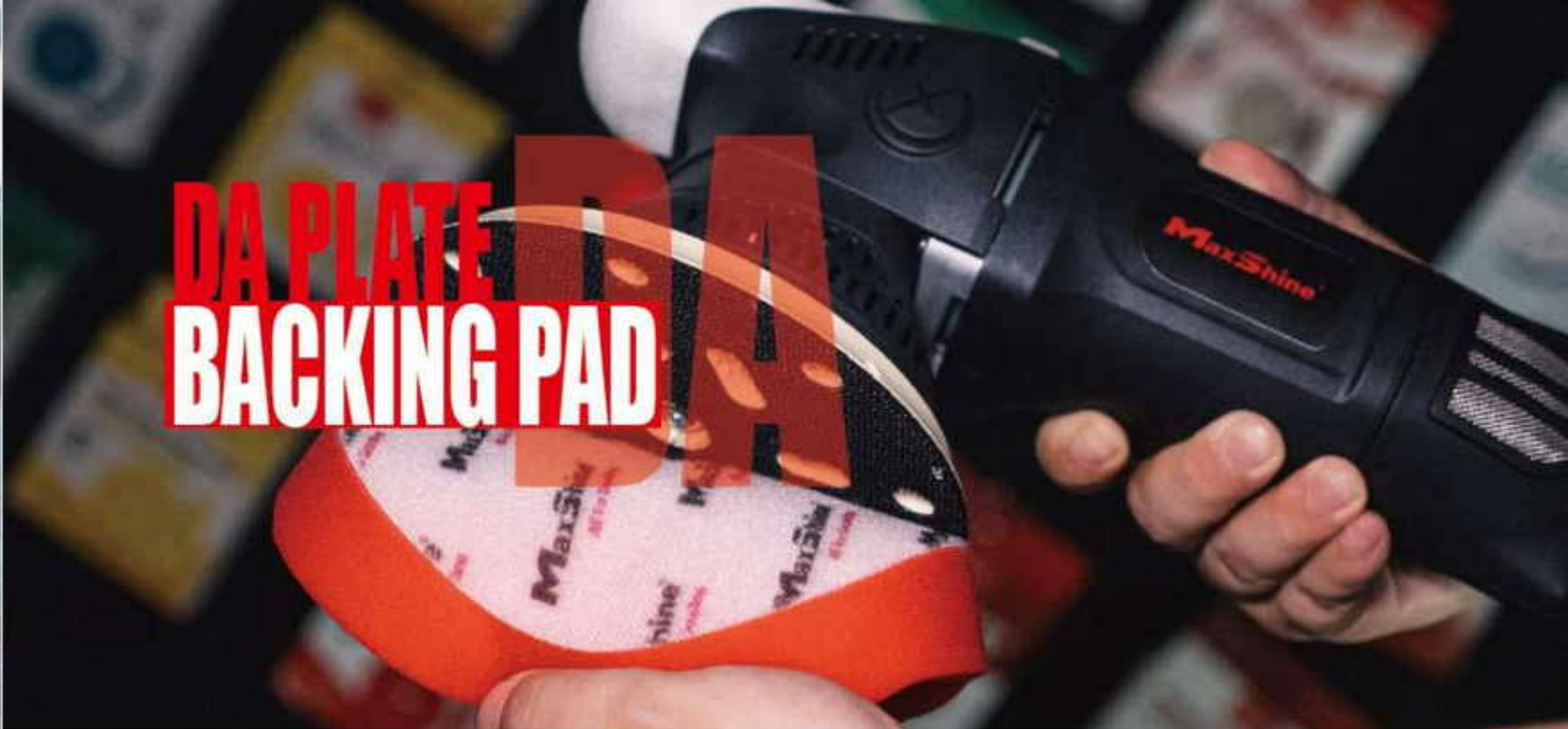

DA Backing Plate



ITEM NO. MS-PBP125-L 5" (Ø125mm)

ITEM NO. MS-PBP150-L 6" (Ø150mm)

Thread 5/16" -24

8/9mm Orbit DA Backing Plate



ITEM NO. MS-BP125

ITEM NO. MS-BP125-H 5" (Ø125mm)

ITEM NO. MS-BP150

ITEM NO. MS-BP150-H 6" (Ø150mm)

DA Backing Plate For Polisher



ITEM NO. MS-PBP50 2" (Ø50mm)

ITEM NO. MS-PBP75 3" (Ø74mm)

ITEM NO. MS-PBP75-B 3" (Ø74mm)

ITEM NO. MS-PBP75-BH(6 holes) 3" (Ø74mm)



ITEM NO. MS-MBP125 5" (Ø125mm)

ITEM NO. MS-MBP150 6" (Ø150mm)

Thread: 5/16"-24, Max OPM:12000

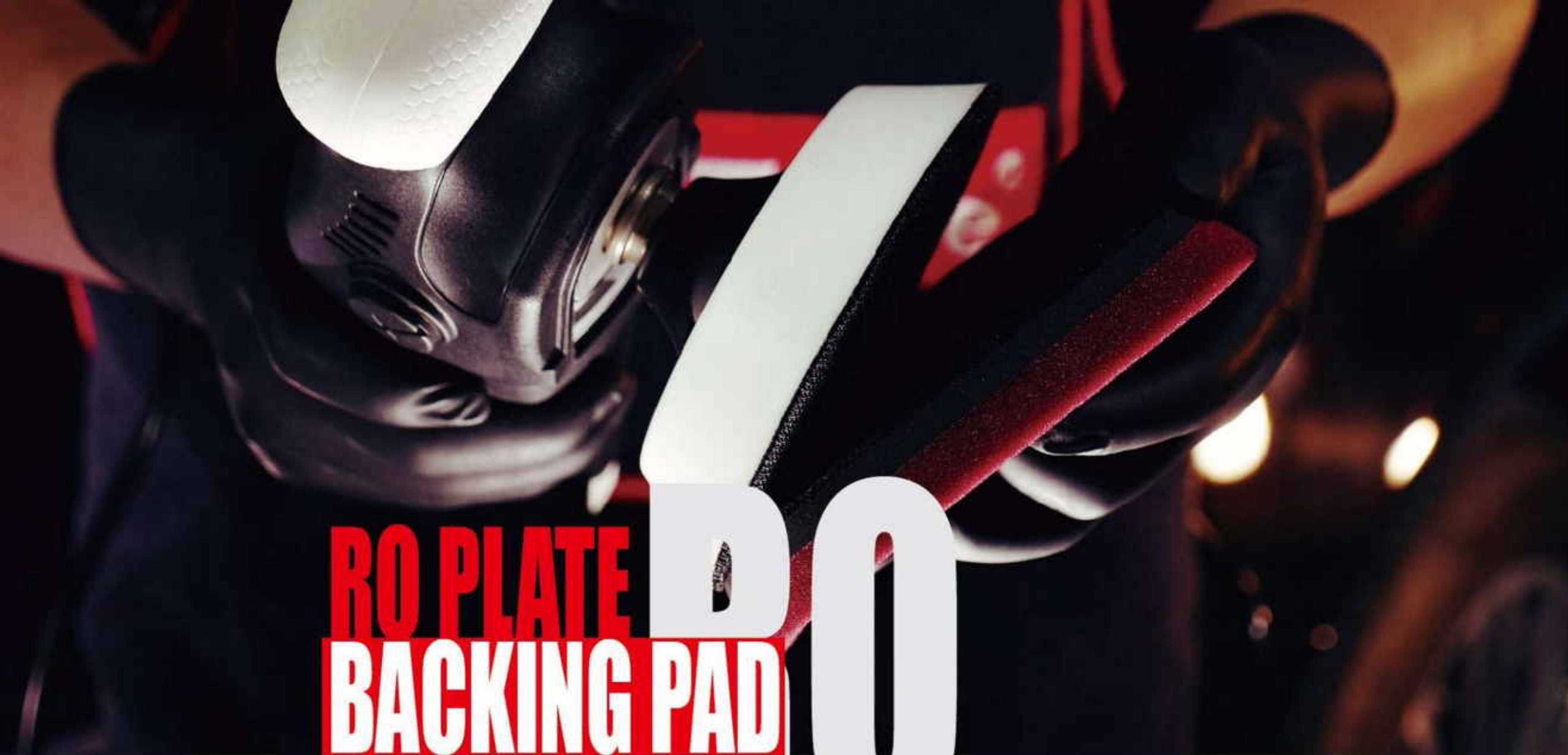

RO PLATE BACKING PAD



Rotary Polisher Backing Plates

Material:
Imported PU with soft edge which protect the painted surface safer.
Hook & loop: velcro Color: white or yellow
Thread: M14 or 5/8"

ITEM NO.	DIAMETER	THREAD	THICKNESS	MAX.RPM
MS-PU01-50	2" (50mm)	5/8,M14	22mm	12000
MS-PU01-70	3" (70mm)	5/8,M14	22mm	12000
MS-PU01-125	5" (125mm)	5/8,M14	27.5mm	8000
MS-PU01-150	6" (150mm)	5/8,M14	27.5mm	8000

Rotary Backing Plate



ITEM NO. MS-PU04-100 4" (∅100mm)
ITEM NO. MS-PU04-115 4.5" (∅115mm)
ITEM NO. MS-PU04-125 5" (∅125mm)
ITEM NO. MS-PU04-150 6" (∅150mm)
ITEM NO. MS-PU04-180 7" (∅180mm)
ITEM NO. MS-PU04-200 8" (∅200mm)
PU Thickness: 15.5mm Thread: M14 or 5/8"

Backing Plate Pad



ITEM NO. MS-PU09-075 3" (∅75mm)
ITEM NO. MS-PU09-125 5" (∅125mm)
ITEM NO. MS-PU09-150 6" (∅150mm)
ITEM NO. MS-PU09-178 7" (∅178mm)
PU Thickness: 10mm Thread: M14 or 5/8"

Flexible Backing Plate For Rotary Polisher



ITEM NO. MS-PU10-125 5" (∅125mm)
ITEM NO. MS-PU10-150 6" (∅150mm)
PU Thickness: 21mm Thread: M14 or 5/8"

Rotary Backing Pad



ITEM NO. MS-PU07-30 1.2" (∅30mm)
ITEM NO. MS-PU07-50 2" (∅48mm)
ITEM NO. MS-PU07-70 3" (∅74mm)
PU Thickness: 12mm Thread: M14 or 5/8"

PREMIUM MICROFIBER TOWEL

A car detailing program is worthless if it adds swirl marks and scratches to your freshly polished paint. Premium Microfiber Towels & Applicators are the finest available anywhere and will not scratch your paint. Guarantee!

Easier to use, softer and safer Microfiber Towels!

Weight Range: 180GSM-1200GSM.

Material: 80% Polyester, 20% Polyamide.

Edging Options: Satin/PE Border/Sewn/Edgeless.

Customized Size/Packing/Label/Colors is available!



**PREMIUM HEAVY
DUTY DETAILING CART**



EDGELESS PLUSH MICROFIBER TOWEL

Both Sides Are Plush High Pile Loop

ITEM NO. MS-EPT4040 / MS-EPT4060

Thickness: 350-1300g/m²

Material: 80% Polyester, 20% Polyamide

Size: 16x16", 16x24"



High Density Soft,
Super Water Absorption.



Edgeless



Lint-free 100% Scratch Free

T&p Super Drying Towel

ITEM NO. MS-TP7590

Thickness: 1000g/m²

Material: 80/20 Blend Split Microfiber

Size: 15x24", 20x30" 24x36" and 30x36"

The Customized size/color are available



High Density Soft,
Super Water Absorption.



Soft Border

DUO TWISTED SUPER DRYING TOWEL

Double Side Twisted Loop

ITEM NO. MS-DTT6090

Thickness: 1200g/m²
Material: 80/20 Blend Split Microfiber
Size: 15x24", 20x30" and 24x36"



Unique supersoft microfiber



Rounded corners trimmed with bound-in satin edging



TWISTED WITH PLUSH DRYING TOWEL

ITEM NO. MS-DTC6090 / MS-DTS6090

Thickness: 1200g/m²
Material: Duo Twisted and Coral Velvet
Size: 24" x36"



Ultimate plush microfiber



Duo Twisted and Coral Velvet double sided



MICROFIBER TEAR AWAY TOWEL ROLL

ITEM NO. MS-MTR3030

Thickness: 260gsm
Blend: 80% Polyester, 20% Polyamide
Material: Terry Pile
Size: 12" x12" (30X30cm)
Pack Qty: 30 sheets per roll.





PLUSH MICROFIBER TOWEL

Both Sides Are Plush High Pile Loops

ITEM NO. MS-PT4040 / MS-PT4060

Thickness: 350-1300g/m²

Material: 80% Polyester, 20% Polyamide Size: 16x16", 16x24"



High Density Soft,
Super Water Absorption.



Soft PE Border

MICROFIBER WAFFLE DRYING TOWEL

Perfect For Drying

ITEM NO. MS-WT4060 / ITEM NO. MS-WT6090

Thickness: 400-450g/m²

Material: 80% Polyester, 20% Polyamide Size: 16x24", 24x36"



Satin Sewing



Waffle Weave
Super Water Absorption



WONDER GLASS CLEANING TOWEL

ITEM NO. MS-WGC4040 / ITEM NO. MS-WGC4060

Thickness: 220gsm with 2mm foam

Material: Microfiber+Foam Size: 16x16", 16x24"



Overlock Stitching
Prevents fraying



Sponge Blend Microfiber
superior absorption & lint-free or streaks-free



Orange Thick Drying Towel
Both Sides Are Plush High Pile Loops

ITEM NO. MS-PT4040-E / MS-PT4060-E

Thickness: 400-1200g/m²
Material: 80% Polyester, 20% Polyamide
Size: 40x40" / 40x60"

Plush Microfiber Towel

Both Sides Are Plush High Pile Loops

ITEM NO. MS-PT5070-D / MS-PT4560-D



Thickness: 400-1300g/m²
Material: 80% Polyester, 20% Polyamide Size: 20x28"

Edgeless Ultra Microfiber Towel

Both Sides Are Short Pile Loops

ITEM NO. MS-EUT4040 / MS-EUT4060



Thickness: 200-450g/m²
Material: 80% Polyester, 20% Polyamide
Size: 16x16", 16x24"

Double Color Microfiber Towel

Both Sides Are Plush High Pile Loops

ITEM NO. MS-PT4040-B / MS-PT4060-B



Thickness: 350-1300g/m²
Material: 80% Polyester, 20% Polyamide
Size: 16x16", 16x24"

Ultra Microfiber Towel

Both Sides Are Short Pile Loops

ITEM NO. MS-UT4040 / MS-UT4060 / MS-UT6090



Thickness: 200-500g/m²
Material: 80% Polyester, 20% Polyamide
Size: 16x16", 16x24", 24x36"



Green Microfiber Glass Scrubbing Towel

ITEM NO. MS-GMT3535
 Size: 35x35cm
 Weight Range: 400-1200GSM
 Material: 80% Polyester, 20% Polyamide,
 Two-Sided Glass Cleaning Towel



Glass Microfiber Towel

ITEM NO. MS-GCMT4040
 Size: 40x40cm
 Thickness: 350-1300g/m
 Material: 80% Polyester, 20% Polyamide



Ultra-Compact Microfiber Towel

ITEM NO. MS-UMT4040
 Size: 40x40cm
 Thickness: 350-1300g/m²
 Material: 70% PET, 30% PA



**Microfiber Towels For
 Streak-Free Drying And Polishing**

ITEM NO. MS-DMT4060
 Size: 40x60cm
 Thickness: 220-1300g/m²
 Material: 80% Polyester, 20% Polyamide

**Dual-Sided Twisted Loop &
 Waffle Weave Drying Towel**

ITEM NO. MS-TLW4040 / MS-TLW6090
 Size: 40x40cm / 60x90cm
 Thickness: Orange Twisted 600GSM, Tiffany Blue Waffle 380GSM

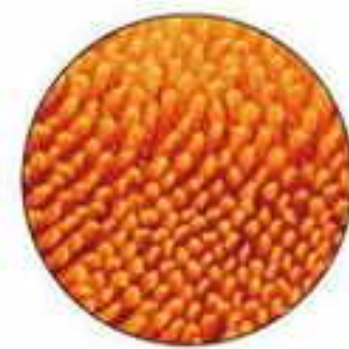

Twisted loop for fast drying

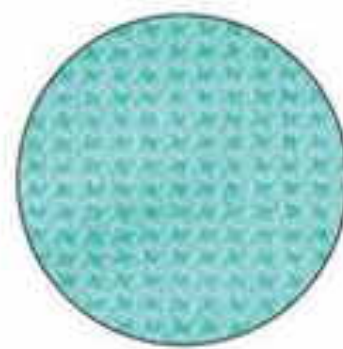

Waffle weave for flawless buffing



Microfiber Suede Towel

Perfect For Coating

ITEM NO. MS-ST4040 / MS-ST4060

Thickness: 180-220g/m²

Material: 80% Polyester, 20% Polyamide

Size: 16x16", 16x24"



Twisted Loop Drying Towel

ITEM NO. MS-TL4040 / MS-TL4060 / MS-TL6090

Thickness: 500g/m²

Material: 70% Polyester, 30% Polyamide

Size: 16x16", 16x24", 24x36"



Silk Border



Fluffy fiber, lint-free, scratch-free, high water absorption.

Gold Plush Microfiber Towel

One Side is Short Pile Loop, The Other Side is High Pile Loop

ITEM NO. MS-CGT4040 / MS-CGT4060



Thickness: 250-550g/m²

Material: 80% Polyester, 20% Polyamide

Size: 16x16", 16x24"

Edgeless Microfiber Cobra Towel

One Side is Short Pile Loop, The Other Side is High Pile Loop

ITEM NO. MS-ECT4040 / MS-ECT4060



Thickness: 250-550g/m²

Material: 80% Polyester, 20% Polyamide

Size: 16x16", 16x24"



Carbon Fiber Towel

Perfect For Clean Glass
ITEM NO. MS-CGT4040-B / MS-CGT4060-B
 Thickness: 360g/m²
 Material: 70% polyester, 15% carbon, 15% polyamide
 Size: 40x40", 40x60"



Glass Microfiber Towel

Perfect For Clean Glass
ITEM NO. MS-GMT4040 / MS-GMT4060
 Thickness: 250-350g/m²
 Material: 80% Polyester, 20% Polyamide
 Size: 16x16", 16x24"



Edgeless Pearl Microfiber Towel

Perfect For Polishing
ITEM NO. MS-EBPT4040 / MS-EBPT4060 (Edgeless Style)
ITEM NO. MS-BPT4040 / MS-BPT4060 (Sewn Style)
 Thickness: 330-350g/m²
 Material: 80% Polyester, 20% Polyamide
 Size: 16x16", 16x24"



Edgeless PU Coated Microfiber Towel

Perfect For Polishing
ITEM NO. MS-PUT300(Edgeless Style)
 Thickness: 300g/m²
 Blend: Polyester 71%, Polyamide 11%, PU 18%
 Size: 15x15", 15x24"



Cloudforce Car Wash Wash Drying Towel

ITEM NO. MS-CF4545

Size: 44x46 cm

Weight: 900 GSM

Material: CloudForce Microfiber



Twisted & CloudForce Car Wash Drying Towel

ITEM NO. MS-TCF7090

Size: 71x88 cm

Weight: 900 GSM

Material: Twist Loop Weave+CloudForce Microfiber



**Twisted Loop Drying Towel
with Pockets**

ITEM NO. MS-TL6011-P

Size: 60x110 cm

Weight: 800 GSM

Material: Single Twist Loop and Woven Microfiber



**Microfiber Wheel
Scrubbing Belt**

ITEM NO. MS-WWS01

Thickness: 700gsm Size: 74x7x2.5cm

Material: Microfiber with Nylon Ribbon



PVA Synthetic Chamois

ITEM NO. MS-PVA4366 Size: 43x66cm

ITEM NO. MS-PVA3243 Size: 32x43cm

Absorbs water 3x faster than a regular towel or chamois



Flat Style



PVA Synthetic Chamois

ITEM NO. MS-PVA4366W Size: 43x66cm

ITEM NO. MS-PVA3243W Size: 32x43cm



Waffle



Suede Microfiber
Detailing Coating Cloth

ITEM NO. MS-MDC1010

thickness: 200gsm size: 10x10cm(4"x4")



Microfiber Detailing Apron

ITEM NO. MS-MDA01

thickness: 250-350g/m² 80% Polyester, 20% Polyamide
Waterproof Back PE Border, soft, safe



Microfiber Detailing Apron

ITEM NO. MS-MDA02

thickness: 500g/m² 80% Polyester, 20% Polyamide
Size: 77cmx89cm Double coral velvet

PREMIUM MICROFIBER WASH MITT

Microfiber cleaning mitts by Maxshine are soft and effective to wash your car without any scratches. Maxshine wide selection of car detailing products offers you fast and easy cleaning or washing work. Wash mitt is an effective and useful way to care for your car.





Plush Microfiber Wash Mitt

ITEM NO. MS-PWM08

Material: 92% Polyester, 8% Viscose

Features: Soft Plush Microfiber, Thick Pile Perfect cleaning, Super Water Absorption.

Size: 28x20cm



High Density with better elasticity



Soft Plush Microfiber, Thick Pile Perfect cleaning, Super Water Absorption.

Plush Microfiber GLOVES

ITEM NO. MS-PWM14

Material: Ultra Soft Plush Microfiber

Features: Avoids Leaving Oils from Hand and Finger Prints. Washable and Re-Usable.

Size: One size fits all (12 x 20.5cm)



High Density with better elasticity

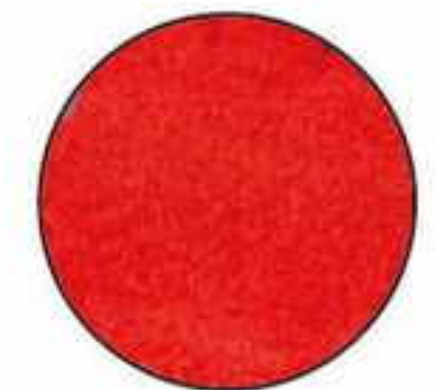

Pairs with Microfiber Safe Soap Form-Fitting



**Ultra-plush Microfiber
Car Wash Mitt with Thumb**

ITEM NO. MS-PWM19

Size: 280x190mm



**Ultra-Plush Microfiber
Car Wash Mitt**

ITEM NO. MS-PWM20

Size: 280x190mm



**Ultra-Plush Microfiber
Car Wash Sponge**

ITEM NO. MS-CCP12

Size: 238x128x74mm



**Plush Microfiber
Thumb Gloves**

ITEM NO. MS-PWM09
Size: 29x21cm



**Microfiber
Wash Glove**

ITEM NO. MS-PWM10
Size: 30x(12-26)cm



**Microfiber Plush
Wash Mitt**

ITEM NO. MS-PWM01
Size: 28x22cm



**Plush Chenille
Wash Mitt**

ITEM NO. MS-PWM05
Size: 24x17cm



**Chenille Microfiber
Wash Mitt**

ITEM NO. MS-PWM06
Size: 24x17cm
Customized color for the back side is available
Material:80% Polyester,20% Polyamide



**Plush Microfiber
Colorful Wash Mitt**

ITEM NO. MS-PWM13
Size: 28cmx18.5cm (11.02"x7.28")



**Duo Twisted
Wash Mitt**

ITEM NO. MS-PWM17
Size: 23x18x2cm
Material:Microfiber



**Microfiber
Wash Mitt**

ITEM NO. MS-PWM15
Size: 23.5x19x2cm
Material:Microfiber



**Microfiber With Waffle
Wash Mitt**

ITEM NO. MS-PWM12
Size: 28cmx18cm (11.02"x7.09")



Chenille Wash Mitt

ITEM NO. MS-PWM16
Size:26x20x5cm
Material:Double Sides Chenille

PREMIUM MICROFIBER WASH PAD

Car washing pads save you time and effort during your journey of car detailing. Maxshine offers you with variety of car washing pads to suit your needs.





Microfiber Wash Pad

ITEM NO. MS-CCP06

Size: 23x17cm

Material: 92% Polyester, 8% Viscose
Plush Microfiber Long Pile ,Quality Reliable Sponge
Plush Chenille Microfiber ,Lint-Free, Easy to remove
dirt from car.Enjoy Car Detailing.



Soft Plush Microfiber,
Thick Pile Perfect cleaning,
Super Water Absorption.



ITEM NO. MS-CCP01
Size: 22.5x12.5x5.5cm



ITEM NO. MS-CCP02
Size: 22x11x5.5cm



ITEM NO. MS-CCP07
Size: 23x(8.5-10.5)x5cm



ITEM NO. MS-CCP08
Size: 22.5x(8.5-10.5)x5.5cm



ITEM NO. MS-CCP10
Size: 18.5x(8.5-13.5)x(0.5+5.5)cm



ITEM NO. MS-CCP11
Size: 26 x 19.5cm



ITEM NO. MS-CCP03
Size: 21x11x5.5cm



ITEM NO. MS-CCP09
Size: 22x17cm



ITEM NO. MS-CCP04
Size: 20x12x6cm or 12x10x3.5cm





SHEEPSKIN NATURAL WASH MITT

Wool mitt is premium quality for cleaning your car surface easily and comfortably removing stain, grime, or dirt. Comfortable design and durability make this one of the best sheepskin mitts & pad on the market.

Finger Wheel Wool Wash Mitt

ITEM NO. MS-WWM09

Size: 15x5x14.5cm

Material: 100% Genuine Lambs Wool

This Wool Finger Mitt is a four finger wash mitt made from 100% genuine lambs wool. The lambs wool is soft enough to not leave scratches on your paintwork when in use.



ITEM NO. MS-WWM07
Size: 240x160mm

Premium Wool Wash Mitt - Mesh Back

ITEM NO. MS-WWM10

Size: 150x250mm

Material: 100% Australian Wool



Genuine Sheepskin Wool Wash Mitt

ITEM NO. MS-WWM08

Size: 30x20cm

Material: 100% Sheepskin Wool



ITEM NO. MS-WWM01
Size: 300x200mm



ITEM NO. MS-WWM05
Size: 300x200mm



ITEM NO. MS-WWM02
Size: 300x230mm



ITEM NO. MS-WWM06
Size: 180x260mm



ITEM NO. MS-WWM03
Size: 350x160mm



ITEM NO. MS-WWP01
Size: 230x230mm



ITEM NO. MS-WWM04
Size: 110x90mm



ITEM NO. MS-WWP02
Size: 230x230mm



SCRUB NINJA SPONGE

Scrub interior vehicle surfaces like plastic, leather and vinyl clean with the brush-like, bristle-type fabric on this nylon sponge scrubber. The firm but gentle fibers scrub deep into fabric pours and contours. **AGGRESSIVE BUT GENTLE CLEANING** – The stiff nylon bristles brush away debris gently and with ease. More aggressive than a microfiber towel but more gentle than a melamine sponge.



Tire Dressing Applicator With Barrier Layer
ITEM NO. MS-SNS07
 Size: 4in. x 3in. x 2in.
 Material: 80/20 Blend Twisted Fiber



Scrubbing Block Car Sponge
ITEM NO. MS-SNS04
 Size: 5 in. x 3 in. x 2 in.
 Material: 100% Nylon Brush Fabric 80/20 Microfiber Mesh Fabric



Scrub Ninja-Finger Mitt
ITEM NO. MS-SNS06
 Size: 12x8cm
 Material: 100% Nylon Brush Fabric 80/20 Microfiber Mesh Fabric



Scrub Ninja – Interior Scrubbing Mitt
ITEM NO. MS-SNS03
 Size: 8 in. x 6 in.
 Material: 100% Nylon Brush Fabric 80/20 Microfiber Mesh Fabric



Wedge Scrubber Block
ITEM NO. MS-SNS05
 Size: 5 in. x 2.5 in. x 2 in.
 Material: 100% Nylon Brush Fabric 80/20 Microfiber Mesh Fabric





Interior Scrubbing Sponge

ITEM NO. MS-SNS01

Size: 13.5x8x2cm

**Material: 100% Nylon Brush Fabric on one side
and 80/20 Microfiber on the other**

- All-in-one Scrubbing Sponge removes dirt, dust, fingerprints, and stains from interior surfaces
- Bristle-like fibers reach deep to remove the toughest of stains
- Perfect for leather, vinyl, soft plastics, and upholstery



Soft microfibers will apply an even coat of protectant



Interior Scrubbing Sponge-Duo Bristle Side

ITEM NO. MS-SNS02

Size: 13.5x8x2cm

Material: 100% Nylon Bristle on both sides

- All-in-one Scrubbing Sponge removes dirt, dust, fingerprints, and stains from interior surfaces
- Bristle-like fibers reach deep to remove the toughest of stains
- Perfect for leather, vinyl, soft plastics, and upholstery



Soft microfibers will apply an even coat of protectant



FOAM POLISHING PAD

Maxshine foam polishing pads are professional designed for the restoration on painted surface and the daily maintenance. The entire series adopt the high quality polyester sponge made in Europe, which possess the advantage of excellent tensile strength and durability, and the service life of which is several times longer than that of the ordinary sponge. You can select out the appropriate hard or soft foam pad according to the process and the polish/wax being used, and make the most ideal gloss finish on the surface.

P=Polishing C=Cutting F=Finishing

A SERIES

Professional Foam Polishing Pad

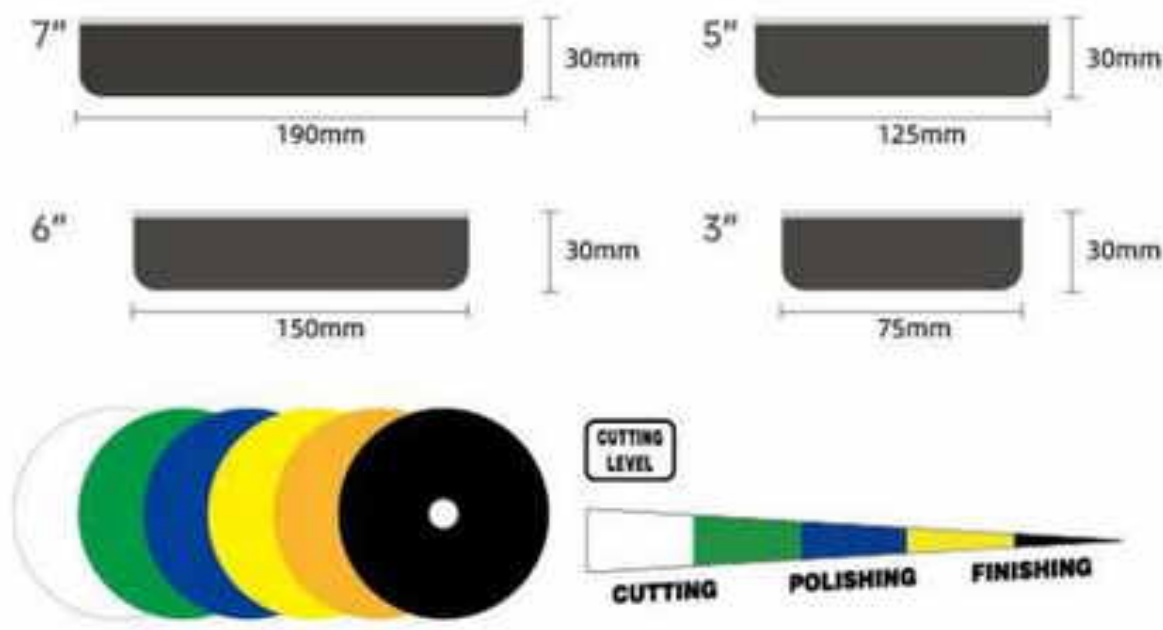

Cutting	Dark Red/Yellow/White/Green/Blue
Polishing	Orange/Yellow/White/Green
Finishing	Green/Blue/White/Red/Black

ITEM NO.	SIZE
A3-75	3" Ø 75x30mm
A5-125	5" Ø 125x30mm
A6-150	6" Ø 150x30mm
A7-190	7" Ø 190x30mm

D SERIES

Cross Cut Foam Pad

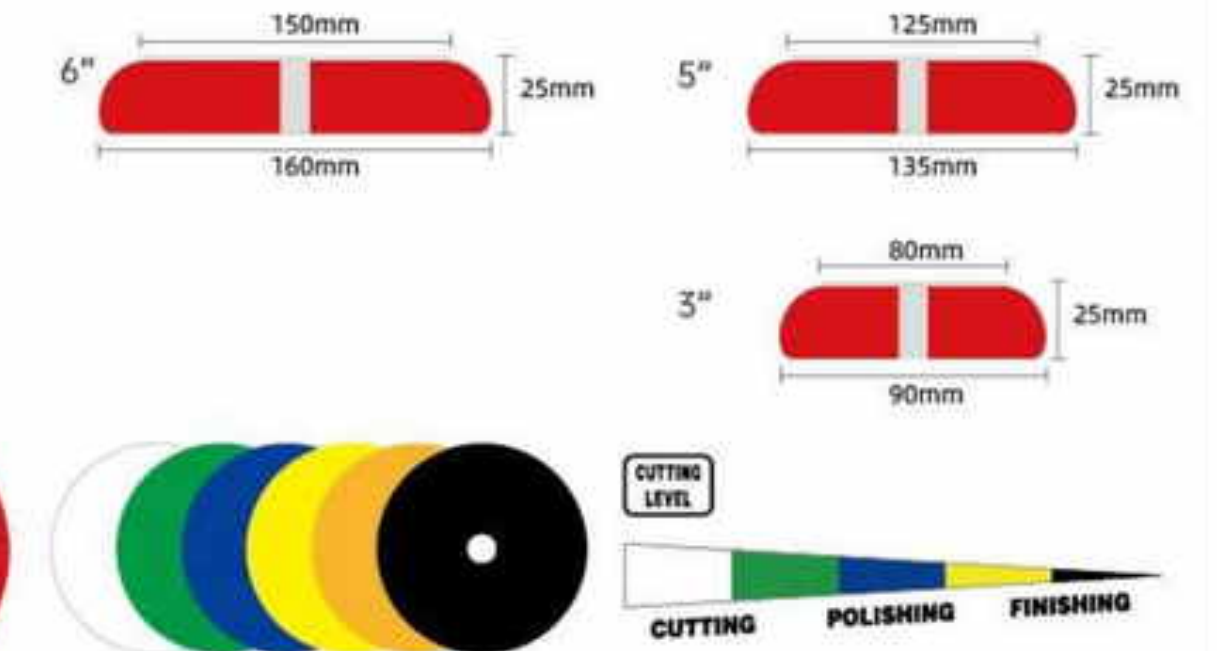

Cutting	Dark Red/Yellow/Blue
Polishing	White/Green
Finishing	Red/Blue/White/Black/Green

ITEM NO.	SIZE
D3-80	3" Ø 80x25mm
D5-125	5" Ø 125x25mm
D6-150	6" Ø 150x25mm

C SERIES

Recessed Backing Foam Polishing Pad

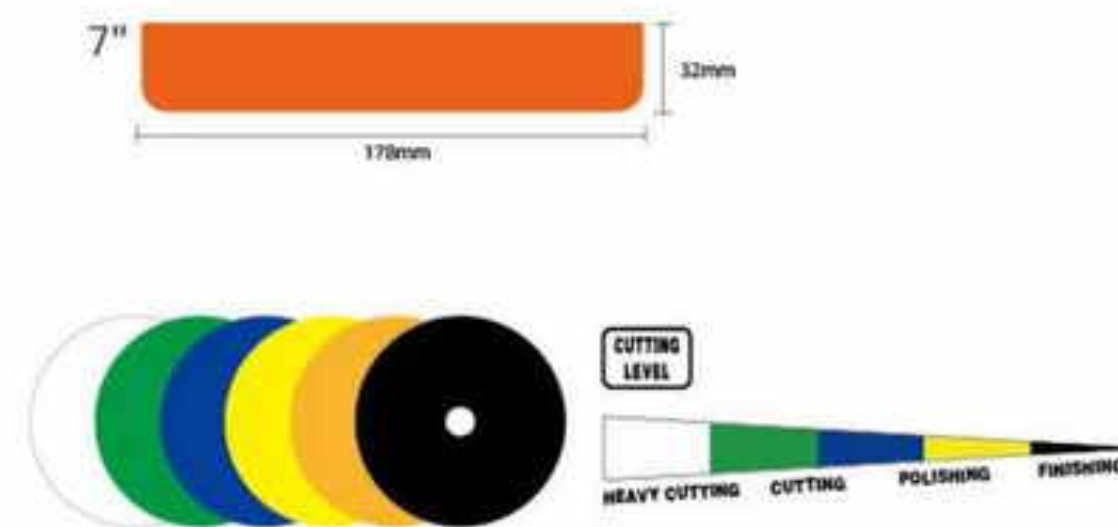

Heavy Cutting	Grey
Cutting	Orange/Dark Red/Yellow
Polishing	Blue/Yellow/Dark Red
Finishing	Blue

ITEM NO.	SIZE
C7-178	7" Ø 178x32 mm

E SERIES

Polishing Corrugated Velcro Foam Pad

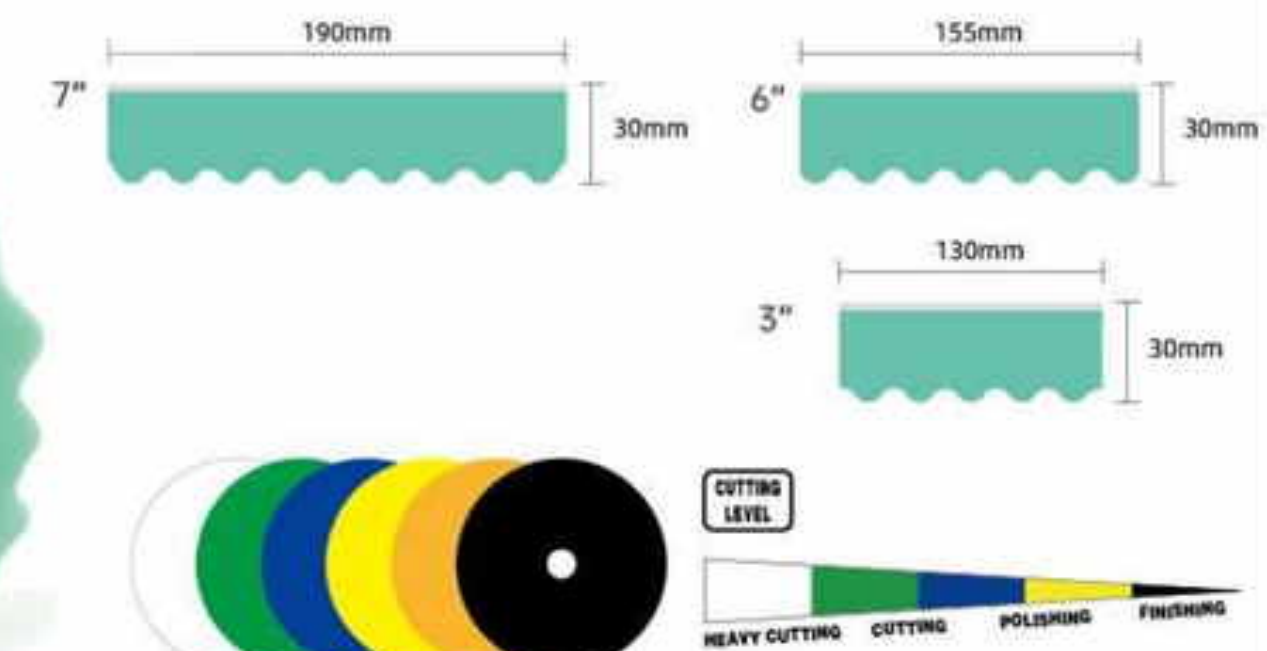

Heavy Cutting	Green/Blue
Cutting	Dark Red/Yellow/Orange
Polishing	Green/Blue/Yellow/Dark Red
Finishing	Green/Blue/Black

ITEM NO.	SIZE
E5-130	5" Ø 130x30mm
E6-155	6" Ø 155x30mm
E7-190	7" Ø 190x30mm

F SERIES

Duo Flat Foam Polishing Pad

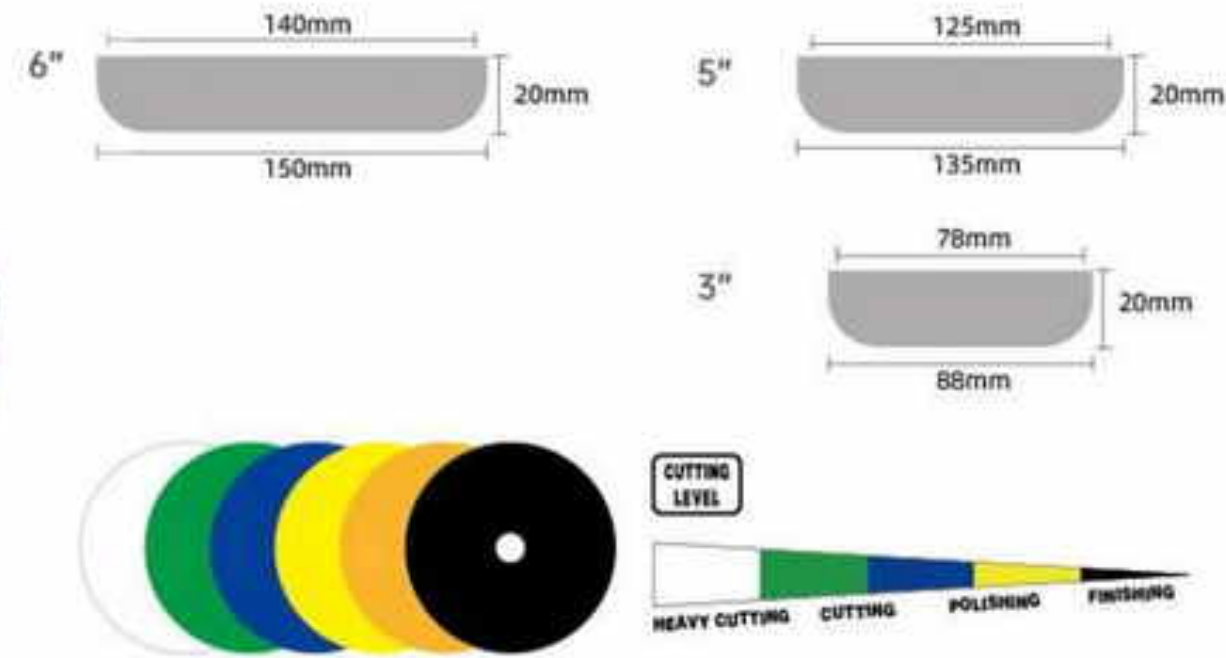

Heavy Cutting	Green/Blue/Grey
Cutting	Dark Red/Yellow/Blue
Polishing	Green/Blue/Yellow/Dark Red/White
Finishing	Green/Blue/White

ITEM NO.	SIZE
F3-78	3" Ø 78x20mm
F5-125	5" Ø 125x20mm
F6-140	6" Ø 140x20mm

H SERIES

Twill Polishing Pads

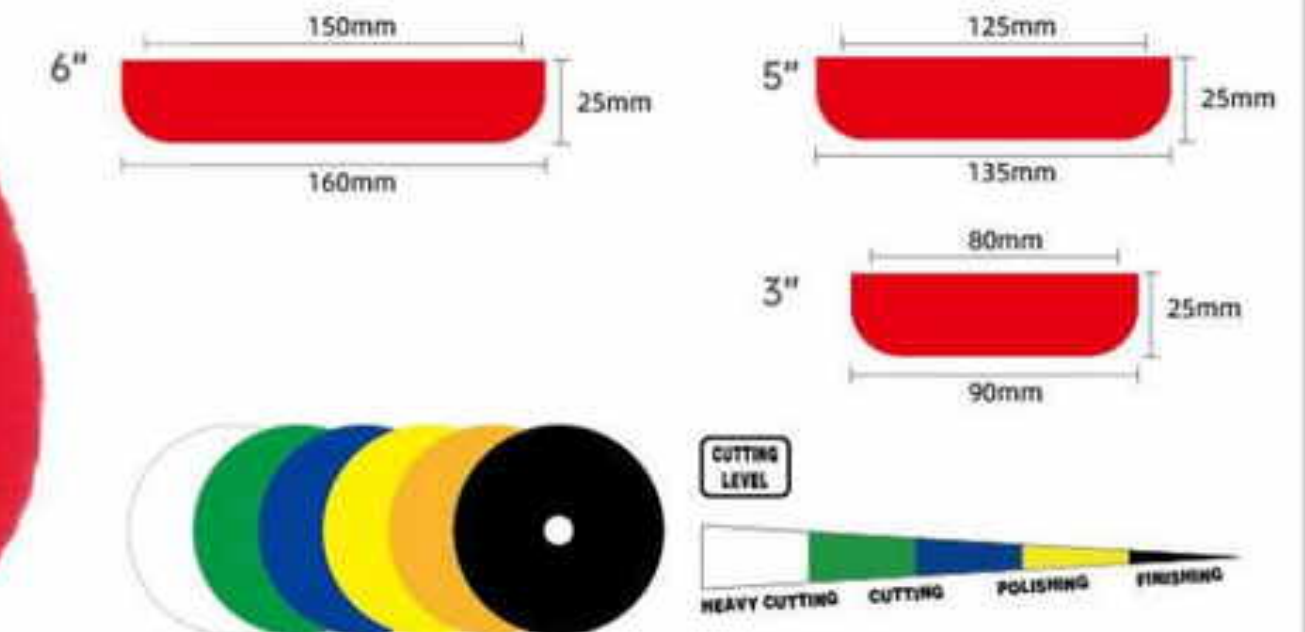

Heavy Cutting	Green/Grey
Cutting	Dark Red/Orange/Red
Polishing	Green/Red/Dark Red
Finishing	Green/Red

ITEM NO.	SIZE
H3-80	3" Ø 80x25mm
H5-125	5" Ø 125x25mm
H6-150	6" Ø 150x25mm

G SERIES

High Pro Foam Polishing Pad

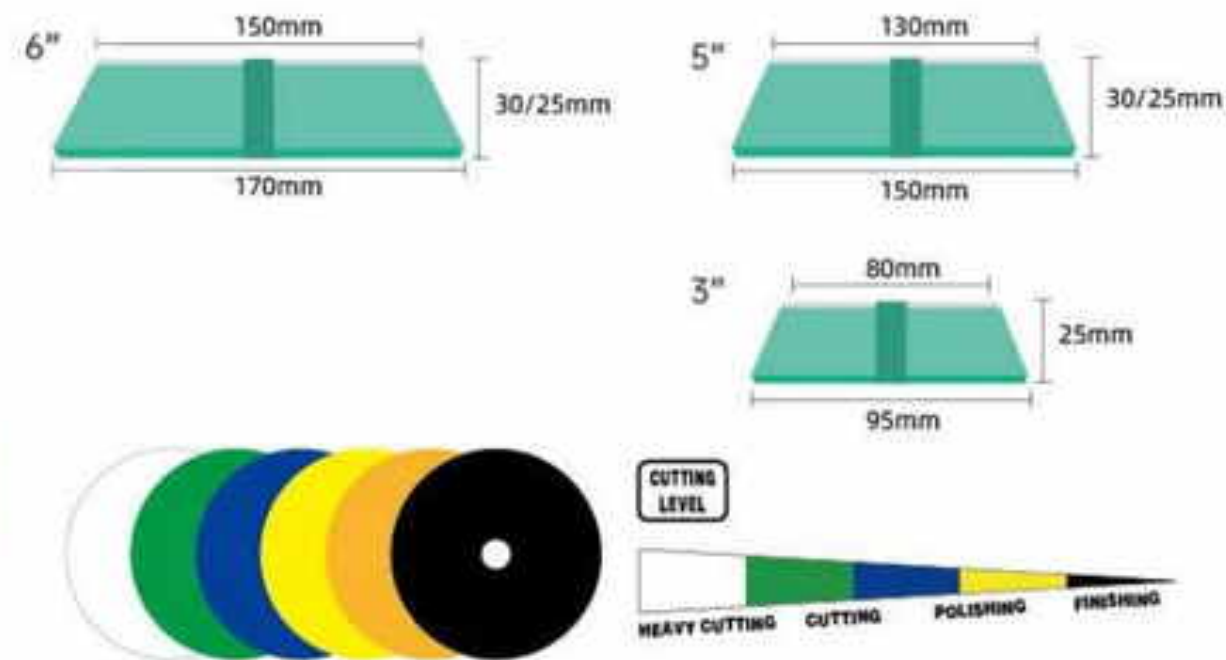

Heavy Cutting	Grey/Green/Blue
Cutting	Dark Red/Yellow/White/Green/Blue
Polishing	Orange/Yellow/White/Green
Finishing	Green/Blue/White/Red/Black

ITEM NO.	SIZE
G3-80	3" 80-95X25mm
G5-130	5" 130-150X30/25mm
G6-150	6" 150-170X30/25mm

I SERIES

Diamond Foam Pad

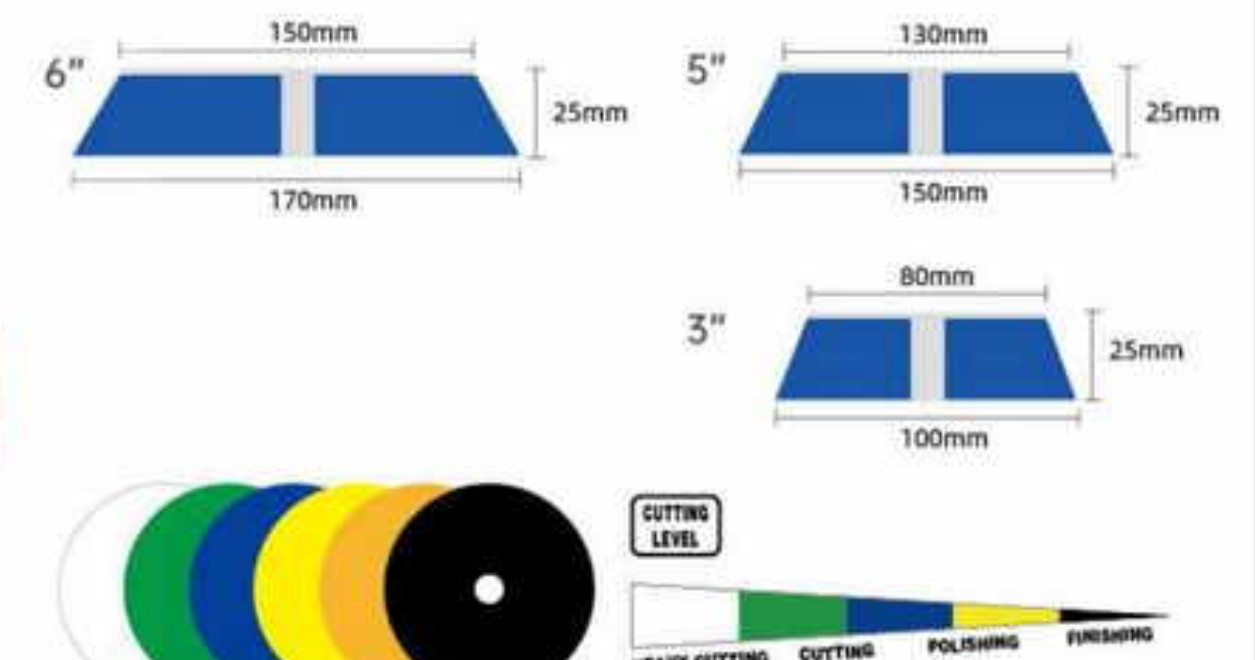

Heavy Cutting	Green/Blue/Grey
Cutting	Red/Yellow
Polishing	Green/Blue/Yellow/Red
Finishing	Green/Blue/Red

ITEM NO.	SIZE
I3-80	3" Ø 80x25mm
I5-130	5" Ø 130x25mm
I6-150	6" Ø 150x25mm

J SERIES

EVA Double Color Foam Polishing Pad For DA

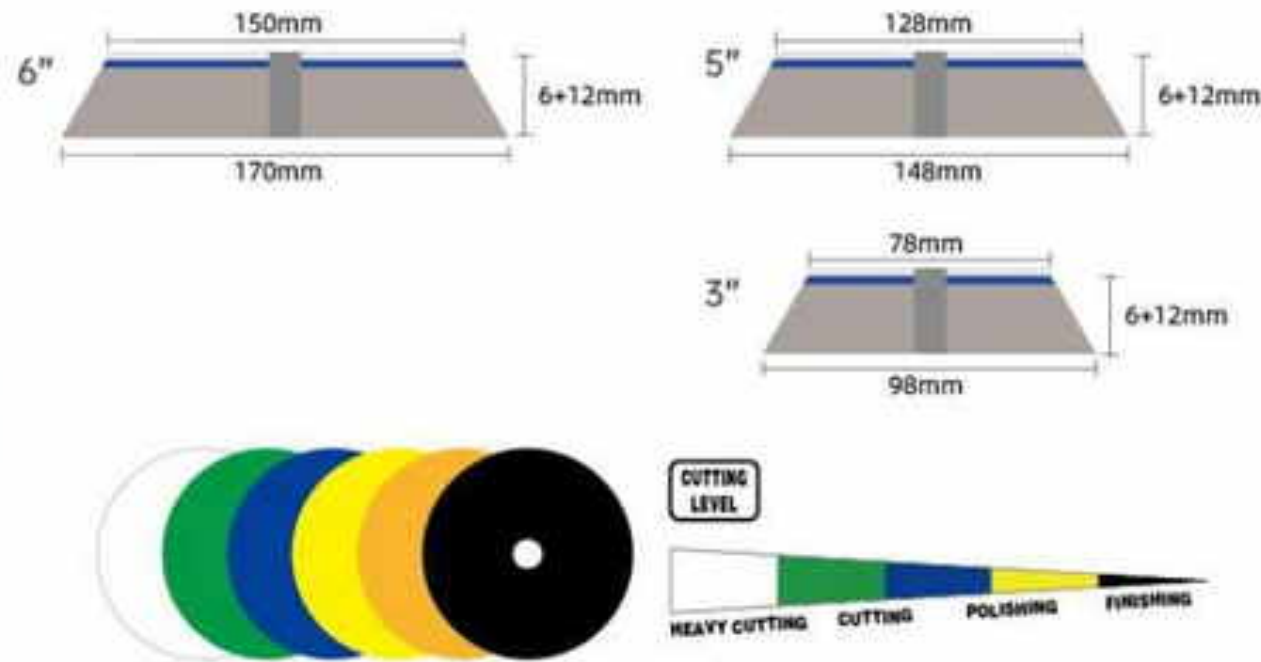

Heavy Cutting	Green
Cutting	Orange/Green
Polishing	Green/Yellow/White
Finishing	Green/Black/White/Red

ITEM NO.	SIZE
J3-78	3" Ø 78x6+12mm
J5-128	5" Ø 128x6+12mm
J6-150	6" Ø 150x6+12mm

S SERIES

Foam Polishing Pad-Flat Face

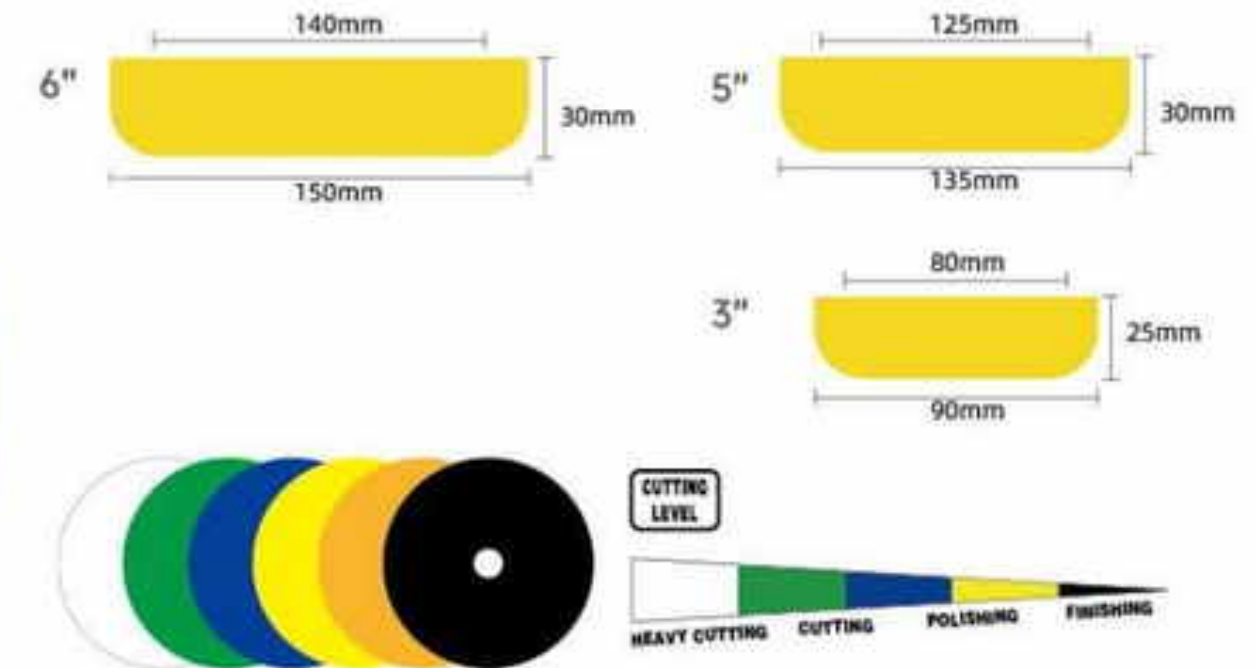

Heavy Cutting	Green/Blue
Cutting	Red/Yellow
Polishing	Green/Blue/Red/White/Yellow
Finishing	Green/Blue/White/Red

ITEM NO.	SIZE
S3-80	3" Ø 80x25mm
S5-125	5" Ø 125x30mm
S6-140	6" Ø 140x30mm

K SERIES

High density Hex-logic Polishing Pad

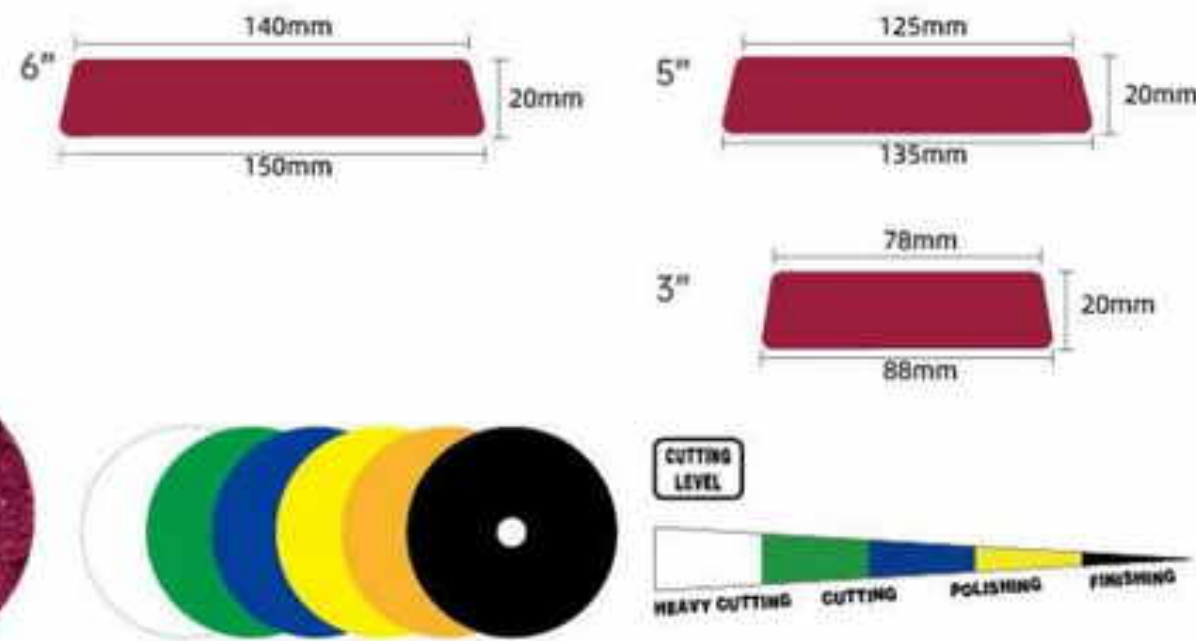

Heavy Cutting	Grey/Green/Blue
Cutting	Drak Red/Orange/Blue
Polishing	Green/Blue/Drak Red/White
Finishing	Green/Blue/White

ITEM NO.	SIZE
K3-78	3" 78X20mm
K5-125	5" 125X20mm
K6-140	6" 140X20mm

FOAM POLISHING
ITEM NO. MS-FPC80
Ø 80mm
Mounting: 6mm Shaft



Interface Pads

- ITEM NO. MS-IP1506" Ø 150x10mm
 - ITEM NO. MS-IP1255" Ø 125x10mm
 - ITEM NO. MS-IP75 3" Ø 75x10mm / 75x6mm
 - ITEM NO. MS-IP50 2" Ø 50x10mm / 50x6mm
- Options: With holes or not

Orange Peel Removed Pad

- ITEM NO. MS-OPP2000-80A Ø80x8mm
 - ITEM NO. MS-OPP2000-100A Ø100x8mm
 - ITEM NO. MS-OPP2000-135A Ø135x8mm
 - ITEM NO. MS-OPP2000-160A Ø160x8mm
- Denim



Orange Peel Removed Pad

- ITEM NO. MS-OPP3000-80A Ø80x8mm
 - ITEM NO. MS-OPP3000-100A Ø100x8mm
 - ITEM NO. MS-OPP3000-135A Ø135x8mm
 - ITEM NO. MS-OPP3000-160A Ø160x8mm
- Velvet

PREMIUM MICROFIBER DA PAD





MD SERIES Heavy Cutting Microfiber DA Pad





ITEM NO.	SIZE
MD3-85	3" 85-100x(6+8)mm
MD5-125	5" 125-145x(6+8)mm
MD6-150	6" 150-170x(6+8)mm

MC SERIES Checkered Microfiber DA Pad



ITEM NO.	SIZE
MC3-80	3" 80x8mm
MC5-130	5" 130x8mm
MC6-140/MC6-150/MC6-160	6" 140/150/160x8mm

ME SERIES Microfiber DA Pad

ITEM NO.	SIZE
ME3-80	3" 80x13mm
ME5-130	5" 130x13mm
ME6-155	6" 155x13mm

WOOL POLISHING PAD

Knitted wool pads offered by Maxshine are of 100% wool content, the customized manufacturing technics produces the material in consistent fiber thickness, nap-height and density, less linting, ensure the pad in uniform quality, unlike the variances that can occur with some natural sheepskin pads
Premium performance on abrasive action and heat-resistance. Working with high-cut wax to aggressively remove scratches and oxid, reduces the swirls and leaves a gloss finish.
Style Options: 1. Bevel Edge (Popular) 2. Straight Edge



WA SERIES

Mixed Foam Wool Polishing Pad



ITEM NO.	SIZE
WA3-78	3" 78-90X8mm
WA5-130	5" 130-146X10mm
WA6-150	6" 150-165X10mm

Material: 1200gsm wool
Wool Length: 12mm
Customized size is available.



WC SERIES

Pro Wool Polishing Pad-Fine Pile Grade



ITEM NO.	SIZE
WC3-76	3" 76-90X(6+8)mm
WC5-125	5" 125-145X(6+8)mm
WC6-150	6" 150-170X(6+8)mm

Material:
100% wool+foam+EVA+Velcro
Customized size is available.



WB SERIES

High-Nap Foam Wool Polishing Pad



ITEM NO.	SIZE
WB3-80	3" 80X6mm
WB5-130	5" 130X6mm
WB6-150	6" 150X6mm

Material:
100% Pure wool+foam+Velcro
Wool Length: 20mm
Customized size is available.



WD SERIES

High Nap Heavy-Cut Wool Pad



ITEM NO.	SIZE
WD3-78	3" 78-90X(6+6)mm
WD5-125	5" 125-140X(6+6)mm
WD6-150	6" 150-165X(6+6)mm

Material:
100% wool+foam+EVA+Velcro
Wool Length: 6mm
Customized size is available.

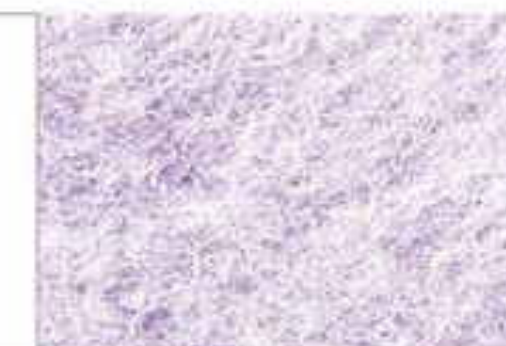

WE SERIES

High Nap Wool Pad For DA&RO Polishers



ITEM NO.	SIZE
WE3-78	3" 78-90X(6+6)mm
WE5-125	5" 125-140X(6+6)mm
WE6-150	6" 150-165X(6+6)mm

Material:
100% wool+foam+EVA+Velcro
Wool Length: 6mm
Customized size is available.



WG SERIES

Wool Buffing Polishing Pads



ITEM NO.	SIZE
WG3-80	3" 80mm
WG5-130	5" 130mm
WG6-150	6" 150mm

Material: wool
Customized size is available.



WF SERIES

Premium Wool Cutting Pad



ITEM NO.	SIZE
WF3-80	3" 80mm
WF5-125	5" 125mm
WF6-150	6" 150mm

Material: natural wool
Customized size is available.



WH SERIES

100% Natural Lace-up Wool Polishing Pad



ITEM NO.	SIZE
WH5-130	3" 130mm
WH6-150	6" 150mm
WH7-178	7" 178mm
WH8-203	8" 203mm
WH9-229	9" 229mm

Material: 100% natural wool
Customized size is available.



100% Wool Compound Pad

Single Sided



ITEM NO.	SIZE
WI75-178	7" 178mm

Material: 4 PLY 100% Twisted Wool / 100% Wool

Note:
Wool material allows quick removal of unwanted imperfections
Recessed cup edge minimizes backing plate contact with surface



Double Sided



ITEM NO.	SIZE
WI9D-229	9" 229mm

Material: 4 PLY 100% Twisted Wool / 100% Wool

Note:
Wool material allows quick removal of unwanted imperfections
Double-sided compound pad designed with unique flexing action



(EU)

Female
M14



Male
M14

(US)

Female
5/8"



Male
M14



Premium High-Nap Wool Polishing Pad



ITEM NO.	SIZE
WL5-130	5" 130x10mm
WL6-155	6" 155x10mm

Wool Length: 20mm
Material:
100% Pure wool+foam+Velcro
Customized size is available.



WM SERIES

Premium Wool Polishing Pad



ITEM NO.	SIZE
WM3-80	3" 80x12mm
WM5-125	5" 125x22mm
WM6-150	6" 150x22mm

Material: wool
Customized size is available.

**WO** SERIES

Knitting Wool Polishing Pads



ITEM NO.	SIZE
WO3-80	3" 80x6mm
WO5-125	5" 125x6mm
WO6-150	6" 150x6mm

Material: wool
Customized size is available.

**WN** SERIES

Heavy-Cut Wool Pad Short-Nap Striped



ITEM NO.	SIZE
WN3-80	3" 80x12mm
WN5-125	5" 125x22mm
WN6-150	6" 150x22mm

Material: wool
Customized size is available.

**WP** SERIES

Purple Foamed Wool Pad



ITEM NO.	SIZE
WP3-80	3" 80x10mm
WP5-130	5" 130x10mm
WP6-155	6" 155x10mm

Material: wool
Customized size is available.

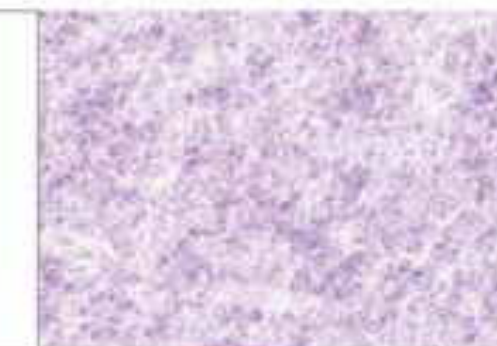

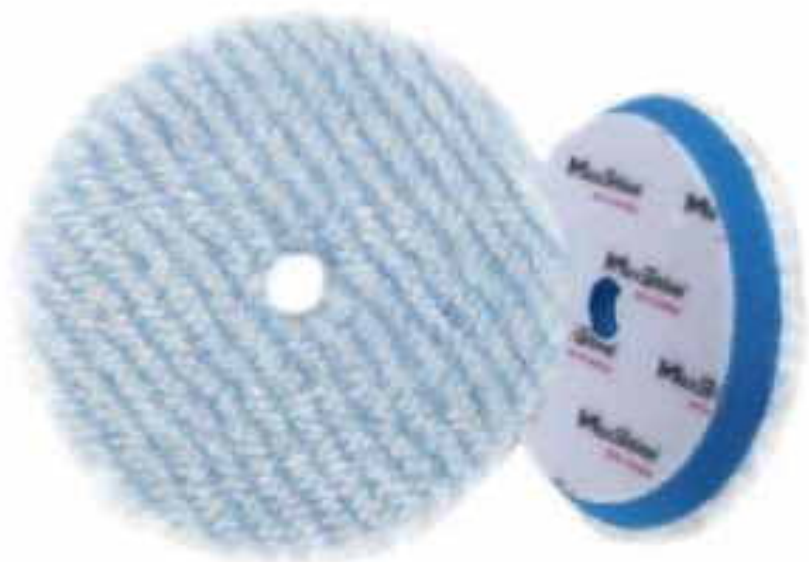
WQ SERIES**Synthetic Wool Cutting Pad**

ITEM NO.	SIZE
WQ3-78	3" 78-90x10mm
WQ5-130	5" 130-146x12mm
WQ6-150	6" 150-165x12mm

Material: wool
Customized size is available.

**WR** SERIES**Mixed Air Cool Wool Polishing Pad**

ITEM NO.	SIZE
WR3-80	3" 80x4mm
WR5-130	5" 130x4mm
WR6-155	6" 155x4mm

Material: 100% Wool
Customized size is available.
Air Cool elastic fiber material
Good dust absorption and heat
dissipation effect.
Mesh air cool elastic fiber has
good air permeability.

**WS** SERIES**Purple Foam Wool Polishing Pad**

ITEM NO.	SIZE
WS3-80	3" 80x6mm
WS5-130	5" 130x6mm
WS6-155	6" 155x6mm

Material: 100% Wool
Customized size is available.

**WT** SERIES**Premium Air Wool Cut and Polish Pad**

ITEM NO.	SIZE
WT3-80	3" 80x4 mm
WT5-130	5" 130x4mm
WT6-150	6" 150x4mm

Material: wool
Customized size is available.



DETAILING BRUSH



Maxshine Detailing Brushes are an essential tool for any detailer. We have kinds of different purpose detailing brush for options. Whether it's for cleaning wheels, trims, engine bays or fabrics detailing brushes are used in every part of the detail to keep your vehicle looking pristine.



Curved Grip XL Detailing Brush

ITEM NO. MS- WB60 Series

Size: 3.3in x 5.9in(including holder)

Color: Red & Black

Handle Material: PP & PTE

Package Includes:

1pc Ultra-Soft Bristle, 1pc Mixed Boar's Bristle Brush,1pc Holder

Curved Grip XL Detailing Brush Ultra Soft

ITEM NO. MS- WB60-1

Diameter: 2.52 inches

Handle Length: 3.09 inches

Hair Length: 2.36 inches(60mm)

Color: Grey & Black

Handle Material: PP & PTE

Hair Material: Ultra Soft Bristle

Package Includes:

1pc Ultra Soft Bristle Brush, 1pc Holder



Curved Grip XL Detailing Brush Mixed Bristle

ITEM NO. MS- WB60-2

Diameter: 2.52 in

Handle Length: 3.09 in

Hair Length: 1.97 in(50mm)

Color: Red & Black

Handle Material: PP & PTE

Hair Material: 20% black Boar's Hair & 80% PET

Package Includes:

1pc Mixed Bristle Brush, 1pc Holder





**Natural Boar's Hair
Detailing Stubby Brush**

ITEM NO. MS-WB64
 Handle Length: 127mm
 Plastic Circle Dia.: 37mm
 Bristle Length: 50mm
 Material: 100% Natural Boar Hair Bristles



**Mixed Bristle
Detailing Stubby Brush**

ITEM NO. MS-WB63
 Handle Length: 127mm
 Plastic Circle Dia.: 37mm
 Bristle Length: 50mm
 Material: 20% Boar's Hair & 80% PET



Ultra-Soft Detailing Brush

ITEM NO. MS-WB70
 Handle Length: 127mm
 Plastic Circle Dia.: 52mm
 Bristle Length: 50mm
 Material: PBT



Flat Detailing Brush

ITEM NO. MS-WB77S
 Handle Length: 147mm
 Handle Width: 29mm

ITEM NO. MS-WB77M
 Handle Length: 174mm
 Handle Width: 49mm
 Material: 30% Black Boar Hair + 70% Black PP



Synthetic Bristles Detailing Brush-Wood Handle

ITEM NO. MS-WB01-25 (4#)	Hair Length:42mm	∅ 25mm, 1"
ITEM NO. MS-WB01-30 (6#)	Hair Length:42mm	∅ 30mm, 1.2"
ITEM NO. MS-WB01-35 (8#)	Hair Length:48mm	∅ 35mm, 1.4"
ITEM NO. MS-WB01-40 (10#)	Hair Length:48mm	∅ 40mm, 1.6"

20% Natural Bristle & 80% PP Bristles , Wood Handle



Synthetic Bristles Detailing Brush-Plastic Handle

ITEM NO. MS-WB02-8#	Ring Dia 17.5mm	Handle Length:127mm
ITEM NO. MS-WB02-10#	Ring Dia 21.5mm	Handle Length:135mm
ITEM NO. MS-WB02-12#	Ring Dia 24.5mm	Handle Length:145mm
ITEM NO. MS-WB02-14#	Ring Dia 27.5mm	Handle Length:147mm
ITEM NO. MS-WB02-16#	Ring Dia 31.5mm	Handle Length:150mm
ITEM NO. MS-WB02-18#	Ring Dia 35.5mm	Handle Length:154mm
ITEM NO. MS-WB02-20#	Ring Dia 38mm	Handle Length:160mm

20% Natural Bristle & 80% PP Bristles , Plastic Handle



100%PET Bristles Detailing Brush-Wood Handle

ITEM NO. MS-WB19-2#	Ring Dia 15mm	Handle Length:55mm
ITEM NO. MS-WB19-4#	Ring Dia 25mm	Handle Length:67mm
ITEM NO. MS-WB19-6#	Ring Dia 30mm	Handle Length:68mm
ITEM NO. MS-WB19-8#	Ring Dia 35mm	Handle Length:70mm
ITEM NO. MS-WB19-10#	Ring Dia 40mm	Handle Length:65mm

100% PET Bristles , Wood Handle



Detailing Brush - White Classic

ITEM NO. MS-M01S-10# Bristle Length:42mm ∅16mm
ITEM NO. MS-M01M-12# Bristle Length:46mm ∅21mm
ITEM NO. MS-M01L-14# Bristle Length:46mm ∅24mm
Bristle Material: White PET
Handle Material: Rubber+Plastic Lacquered

Ergonomically designed non-slip handle for a comfortable grip.
Easy to use and safe on all surfaces. Perfect for narrow or tight spaces.
Great for both interiors and exteriors.
Soft and gentle bristles, densely packed for best cleaning performance.
Constructed with premium PET bristles.

Detailing Brush - Black Classic

ITEM NO. MS-M02S-10# Bristle Length:42mm ∅16mm
ITEM NO. MS-M02M-12# Bristle Length:46mm ∅21mm
ITEM NO. MS-M02L-14# Bristle Length:46mm ∅24mm
Bristle Material: 20% Black Bristle+80% Black PET
Handle Material: Rubber+Plastic Lacquered

Anti-slip and comfortable grip.
Strong yet soft, densely packed bristles for deep cleaning.
Perfect for both interior and exterior detailing.
Works well dry, or wet with your favorite cleaning solution.

Detailing Brush - Boar's Hair

ITEM NO. MS-M03S-10# Bristle Length:42mm ∅16mm
ITEM NO. MS-M03M-12# Bristle Length:46mm ∅21mm
ITEM NO. MS-M03L-14# Bristle Length:46mm ∅24mm
Bristle Material: Natural Brown Bristle
Handle Material: Rubber+Plastic Lacquered

Anti-slip and ergonomic grip.
Perfect for both interior and exterior detailing.
Brush head is densely packed, allowing for optimum cleaning.
Upgraded boar's hair. Soft, gentle, and durable

Detailing Brush - Ultra Soft

ITEM NO. MS-M04S-10# Bristle Length:42mm ∅16mm
ITEM NO. MS-M04M-12# Bristle Length:46mm ∅21mm
ITEM NO. MS-M04L-14# Bristle Length:46mm ∅24mm
Bristle Material: Ultra-Soft Synthetic Bristles
Handle Material: Rubber+Plastic Lacquered

Non-Slip Rubber Handle with comfortable grip.
Constructed of anti-static materials.
Ultra-Soft Synthetic Bristles
Perfect for delicate surfaces that need a gentle touch.



Detailing Brush - Classic Boar's Hair 100%

ITEM NO. MS-M05S
Bristle Dia.: 22mm Bristle Length: 44mm Handle Length: 123.6mm

ITEM NO. MS-M05L
Bristle Dia.: 26mm Bristle Length: 48mm Handle Length: 189.6mm
Material: Natural Brown Bristle



Detailing Brush - Classic Boar'S Hair Mixed

ITEM NO. MS-M06S
Bristle Dia.: 22mm Bristle Length: 44mm Handle Length: 123.6mm

ITEM NO. MS-M06L
Bristle Dia.: 26mm Bristle Length: 48mm Handle Length: 189.6mm
Material: 20% Black Bristle + 80% Black PP



Detailing Brush-Premium Soft

ITEM NO. MS-M07S
Bristle Dia.: 22mm Bristle Length: 44mm Handle Length: 123.6mm

ITEM NO. MS-M07L
Bristle Dia.: 26mm Bristle Length: 48mm Handle Length: 189.6mm
Material: Nylon Electrostatic Bristle



Leather and Alcantara Cleaning Brush

ITEM NO. MS-WB13
Size: 120x40x10mm Hair Length: 20mm
Material: Wooden Handle+ Soft Bristle



Horsehair Cleaning Brush-Small

ITEM NO. MS-WB20
Size: 120x40x10mm Hair Length: 20mm
Material: Wooden Handle+ 100% Horsehair



Horsehair Cleaning Brush-Large

ITEM NO. MS-WB21
Size: 170x55mm Hair Length: 30mm
Material: Wooden Handle+ 100% Horsehair



Soft Leather Brush

ITEM NO. MS-WB07
Size: 170x60mm Hair Length: 30mm
Material: Wooden Handle
+Soft PP/Nylon/Horse Bristle



Ergonomically Leather Brush

ITEM NO. MS-WB08
Size: 150x65mm Hair Length: 30mm
Material: Horse Hair



Nano Fabric/Leather Cleaning Brush

ITEM NO. MS-WB50
Length: 12cm Width: 5.5cm
Height: 3.5cm
Material: Nano Felt

Car Detailing Brush



ITEM NO. MS-WB03

8# ∅ Length 160mm 16# ∅ Length 280mm
 10# ∅ Length 180mm 18# ∅ Length 320mm
 12# ∅ Length 220mm 20# ∅ Length 350mm
 14# ∅ Length 260mm
 Hair Length:45mm
 Material: PP Handle,100% Boar's Hair bristles



ITEM NO. MS-WB25

Handle Length: 205mm Hair Length: 55mm
 Material: PP+ rubberized grip,
 black PBT hard bristle



Lambswool Detailing Duster

ITEM NO. MS-DD01

Wool Part: 25cm
 Handle Length: 60cm



ITEM NO. MS-WB37

Handle Length: 220mm Hair Length: 45mm
 Material: PP+Nylon 612, Electrostatic wool



ITEM NO. MS-WB38

Handle Length: 220mm Hair Length: 45mm
 Material: PP Handle,100% Boar's Hair bristles



ITEM NO. MS-WB39

Handle Length: 220mm Hair Length: 45mm
 Material: PP Handle, 100% sharpening fiber



WB37-KIT Series Handle Length: 220mm Hair Length: 45mm

ITEM NO. MS-WB37

Material: PP+Nylon 612, Electrostatic wool

ITEM NO. MS-WB38

Material: PP Handle,100% Boar's Hair bristles

ITEM NO. MS-WB39

Material: PP Handle, 100% sharpening fiber



Stiff Bristle Detailing Brush

ITEM NO. MS-WB25

Handle Length: 205mm Hair Length: 55mm
 Material: PP+ rubberized grip,
 black PBT hard bristle



ITEM NO. MS-WB62 L

Handle Length: 20.8cm Bristle Length: 4.8cm
 Material: PP Handle+Rubber

ITEM NO. MS-WB62 S

Handle Length: 13.2cm Bristle Length: 4.6cm
 Material: PBT Bristles



ITEM NO. MS-WB59

Size Details: 7.4cm x 3.2cm x 6.3cm
 Material: Nylon, Plastic



Engine Brush

ITEM NO. MS-EB01

Handle Length: 280mm Hair Length: 40mm
 Material: Plastic Handle+ boar hair / PP
 The bristles can be customized, PP and boar hair.



Ultra Soft Detailing Circle Brush

ITEM NO. MS-WB55 Series

Dia.: 5.2cm Height: 6cm Hair Length: 1.8cm
 Material: Nylon

Includes: 1 Brush & 1 Brush Storage Case

ITEM NO. MS-WB55-Y Hair Color: Yellow

ITEM NO. MS-WB55-B Hair Color: Black



Ultra Soft Rounded Brush

ITEM NO. MS-WB80 S Hair Length: 2cm Handle Length:14cm
 ITEM NO. MS-WB80 M Hair Length: 3.5cm Handle Length:15.5cm
 ITEM NO. MS-WB80 L Hair Length: 4.5cm Handle Length:16cm
 ITEM NO. MS-WB80 Serie
 Material: Black plastic handle + Fiber wool
 Package including: 3pcs/pack (small, medium, large)



Ultra Soft Handled Detailing Brush

ITEM NO. MS-WB79
 Handle Length: 6.9cm Handle Width: 4.7cm
 Total Length: 9.5cm Bristle Length: 1.1-2.6cm
 Material: Black Plastic Handle + Ultra-Soft Synthetic Bristles



SOFT GRIP TIRE CLEANING BRUSH
 ITEM NO. MS-WB65
 Size: 222.48*60*12mm
 Material: Red PP+Black TPE Handle
 PP Bristles



SOFT GRIP WHEEL AND BODY BRUSH
 ITEM NO. MS-WB68
 Size: Size: 270.19*72*14.8mm
 Material: Red PP+Black TPE Handle
 PET+PBT Bristles



**SOFT GRIP TIRE & WHEEL CLEANING BRUSH
 LONG HANDLE**
 ITEM NO. MS-WB69
 Size: 523.4*72*15mm
 Material: Red PP+Black TPE Handle
 PET+PP Bristles



Heavy-Duty Wheel And Carpet Cleaning Brush
ITEM NO. MS-WB44
 Size: 8 x 3 x 1in
 PVC hair diameter: 40mm
 Material: PP handle & PVC hair



Exterior Surface And Wheel Cleaning Brush
ITEM NO. MS-WB43
 Size: 8 x 3 x 1in
 PVC hair diameter: 25mm
 Material: PP handle & PVC hair



Medium-Duty Wheel & Body Brush
ITEM NO. MS-WB42
 Size: 8 x 3 x 1in
 PVC hair diameter: 25mm
 Material: PP handle & PVC hair



Tire Scrub Brush
ITEM NO. MS-WB09
 Size: 210x64mm Hair Length: 25mm
 Material: Plastic Handle
 Soft PP/ Nylon/ Horse Bristle



Wheel Brush
ITEM NO. MS-WB32
 Length:270mm Material: PP



Wheel And Engine 360° Cleaning Brush
ITEM NO. MS-WB31
 Length:280mm Material: PP



Leather Cleaning Brush

ITEM NO. MS-WB47

Size: L 12.5 x W 5.5cm Hair Material: Horse +PP
 Hair length: 2.5cm Handle Material: wooden handle

Leather Cleaning Brush is used for gently clean interior, leather seat, vinyl and fabric convertible tops.



Tire Cleaning Brush

ITEM NO. MS-WB48

Size: L 12.5 x W 5.5cm Hair Material: PP
 Hair length: 2.5cm Handle Material: wooden handle

Designed for use on modern alloy wheels this handy brush enables all parts of the tire to be accessed.



TIRE & CARPET CLEANING BRUSH

ITEM NO. MS-WB12

Length:190mm
 Material: PP handle with PP Fiber



Car Carpet Brush

ITEM NO. MS-WB26

Size:160x50mm Hair Length: 30mm
 Material: PP with TPR



Pet Hair Removal Brush

ITEM NO. MS-WB54

Size: 12x4x4cm
 Material: Silicone
 Color: Accept Customization



ITEM NO. MS-WB06
 Length: 170mm
 Material: PP with PP Fiber



ITEM NO. MS-WB16
 Length: 170mm Hair Length: 10mm
 Handle Length: 100mm



ITEM NO. MS-WB50
 Length: 12cm Width: 5.5cm
 Height: 3.5cm
 Material: Nano Felt



Car Carpet Brush
ITEM NO. MS-WB11
 Length: 150mm
 Material: PP



Silicone Interior Detailing Brush
ITEM NO. MS-WB49
 Size: 29x8cm Material: Silicone



Foam Pad Cleaning Brush and Pad Removal Tool
ITEM NO. MS-WB78
 Size: 16.5x3.4x1.3cm
 Material: PP+Polycarbafil+Nylon yam



Mini Pet Hair Car Carpet Brush
ITEM NO. MS-WB
 Size: 10cm
 Color: Red ABS+Black Silicone



Mini Pet Hair Car Carpet Brush
ITEM NO. MS-WB57
 Size: 10cm
 Color: Red ABS+Black Silicone

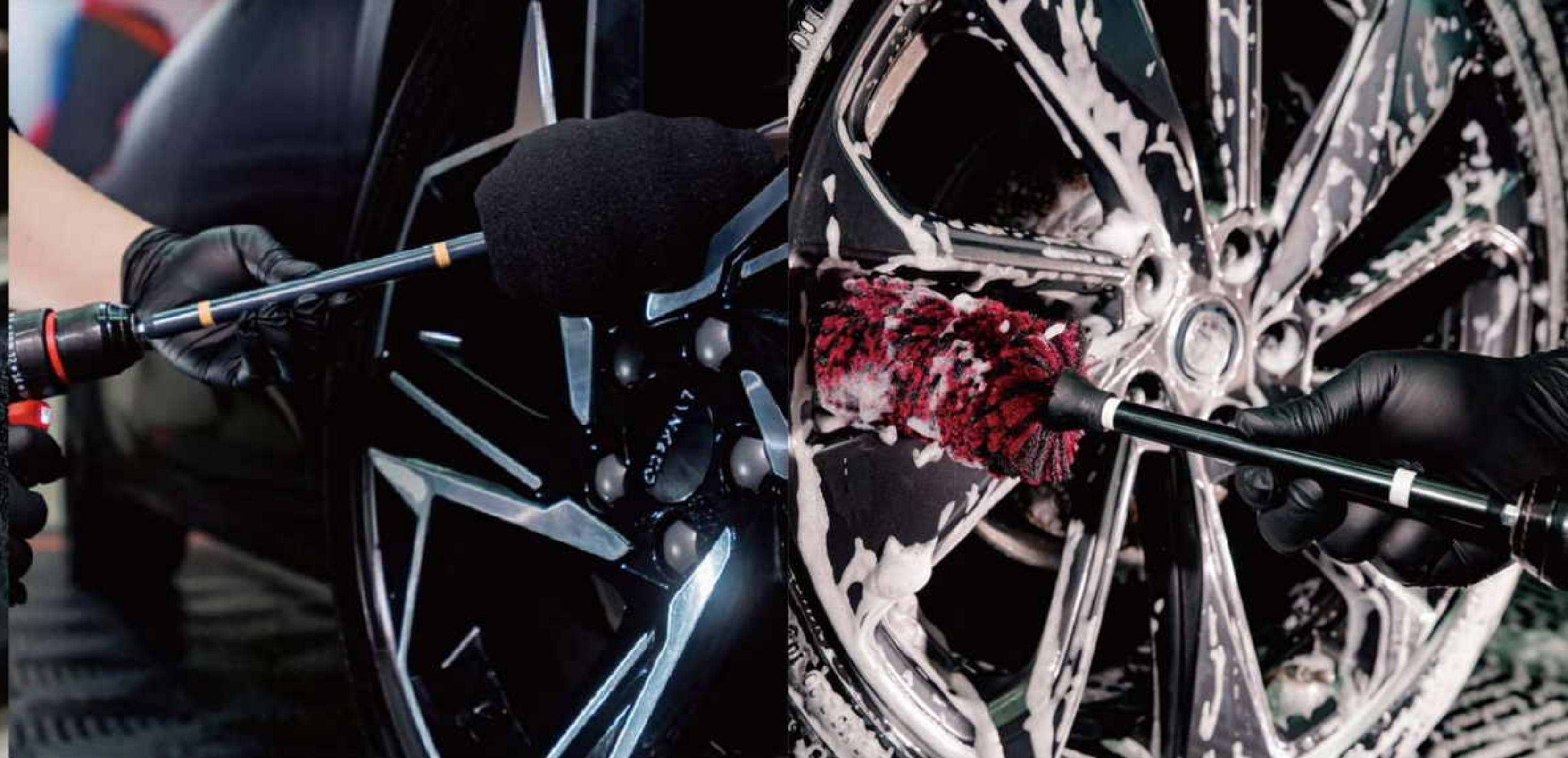

Drill Carpet Brush

ITEM NO. MS-DAB01

Size: Ø125mm / Ø100mm / Ø50mm



Carpet Brush

ITEM NO. MS-DAB03

Size: Ø125mm

Hair length: 23mm / 40mm



Duty Drill Wheel Brush

ITEM NO. MS-DTB01

Hair Length: 30mm

Handle Length: 30mm

Material: Nylon



Synthetic Wool Drill Power Wheel Brush with Drill Adapter

ITEM NO. MS-WBD01

Total length: 37cm Material: Imitation wool



PowerFoam Wheel Brush (Drill Powered)

ITEM NO. MS-DTB03

Size: 35cm Hair Length: 15cm

Material: Premium Foam



Premium Synthetic Wool Wheel Brush (Drill Powered)

ITEM NO. MS-DTB02

Size: 34cm Hair Length: 15cm Hair Dia: 7 cm

Material: Synthetic Wool



Large



Small



Wheel and Rim Brush

ITEM NO. MS-WB17 450mm

ITEM NO. MS-WB18 300mm

Durable, flexible, and safe to use on all wheel types.
Easily reaches delicate nooks and crannies. Extremely Flexible.

50cm

45cm

35cm



100% Microfiber

Microfiber Wheel Brush-3 Pieces Kit

MS-MB-KIT

ITEM NO. MS-MB01 Length:35cm, Microfiber Part Length:15cm, Dia.7cm

ITEM NO. MS-MB02 Length:45cm, Microfiber Part Length:16cm, Dia.9cm

ITEM NO. MS-MB03 Length:50cm, Microfiber Part Length:20cm, Dia.10cm



45 Degree Angle-Microfiber Wheel Brush

ITEM NO. MS-MB04

Length:55cm

Microfiber Part Length:16cm, Dia.7cm



Premium Flat Microfiber Wheel Brush with Replaceable Cover

ITEM NO. MS-MB09 Large
 Total Length: 50cm Microfiber Cover Diameter: 5.5cm
 Microfiber Cover Length: 18.5cm

ITEM NO. MS-MB09-S Small
 Total Length: 36cm Microfiber Cover Diameter: 5.5cm
 Microfiber Cover Length: 14cm

- Features:
- Removable Brush Head for easy cleaning and replacement.
 - Metal-Free Construction ensures safe, scratch-free wheel cleaning.
 - Heavy-Duty Microfiber Sponge Compresses for greater flexibility.



ITEM NO. MS-CWB01 Length:31cm
ITEM NO. MS-CWB03 Length:39cm
ITEM NO. MS-CWB04 Length:42cm
ITEM NO. CWB-KIT01
 Including: 1pc CWB01 1pc CWB03 1pc CWB04

ITEM NO. MS-WB45 Length:45cm
ITEM NO. MS-WB46 Length:25cm
 Material: Synthetic Wool Brush



Ultimate Wool Wheel Brush-3 Pieces Kit

- ITEM NO. MS-WWB01 Length:35cm
- ITEM NO. MS-WWB02 Length:40cm
- ITEM NO. MS-WWB03 Length:45cm
- ITEM NO. MS-WWB-KIT01

Including 1pc MS-WWB01
 1pc MS-WWB02 1pc MS-WWB03
 Much More Aggressive, Fast To Clean Wheel!
 100% Natural Sheepskin Wool!

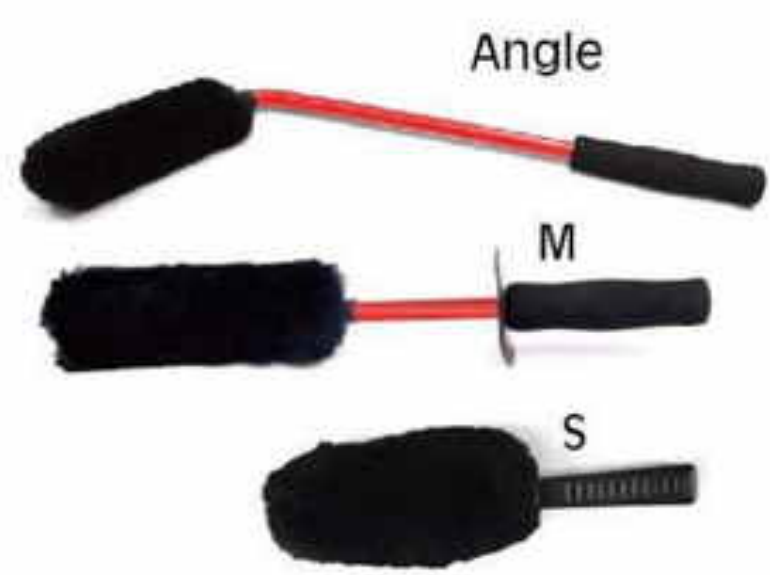
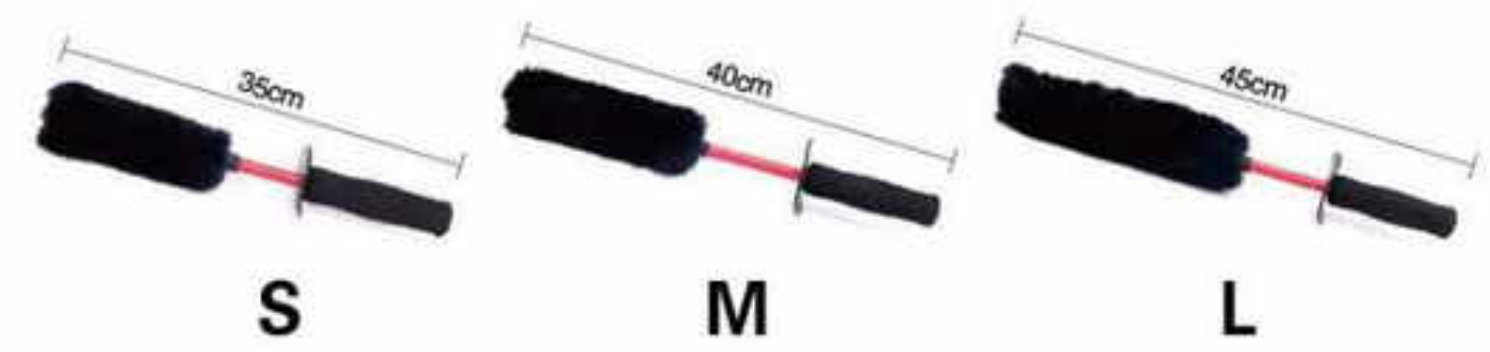

Ultimate Wool Wheel Brush

- ITEM NO. MS-WWB02 Length:40cm
- ITEM NO. MS-WWB05 Length:49cm
- ITEM NO. MS-WWB06 Length:25cm
- ITEM NO. MS-WWB-KIT02

Including
 1pc MS-WWB02
 1pc MS-WWB05
 1pc MS-WWB06



PREMIUM CAR DUSTER



Car Duster Exterior Scratch Free With Extendable Handle

ITEM NO. MS-WB76
Length: 64-88cm (Scalable)
Width: 12cm Bristle Length: 12cm
Material: Cotton Bristles+Extendable Handle



Car Duster Exterior Extendable Handle

ITEM NO. MS-WB75
Length: 64-88cm (Scalable)
Width: 12cm Bristle Length: 12cm
Material: Microfiber Bristles+Extendable Handle



Mini Interior Duster

ITEM NO. MS-WB72
Handle Length: 23cm
Bristle Length: 6cm
Dimension and Weight: 35(L) x 8(W) cm, 0.11kg



Car Duster Combo

ITEM NO. MS-WB74

ITEM NO.	Length	Width	Bristle Length	Handle Length
WB74-Small	33cm	5cm	10cm	12cm
WB74-Large	61cm	8cm	11cm	41cm

Material: Cotton Bristles+ Plastic Handle

Car Duster Premium Combo Kit Wood Handle Classic & Mini Duster

ITEM NO. MS-WB73

ITEM NO.	Length	Width	Bristle Length	Handle Length
WB73-Small	33cm	5cm	10cm	12cm
WB73-Large	61cm	8cm	11cm	41cm

Material: Cotton Bristles+ Wooden Handle

X-Large Premium Car Duster

ITEM NO. MS-WB71

Length: 76cm Bristle Length: 10.6cm

Handle Length: 43cm Width: 16cm

Material: Cotton Bristles+ Wooden Handle



Car Microfibre Universal Brush Cover

ITEM NO. MS-MBC01

Size: 20x31cm

Material: High Quality Microfiber Cotton

Application: Flexible PVC Wash Brush Cover



Car Wash Chenille Brush With Retractable Handle

ITEM NO. MS-FCB01

Size: Pole length from 23.2" extend to 43.3" (55-110cm)

Handle Material: Aluminum Alloy Pipe Walls

Brush Cover Material: Chenille (Customized)

Brush Cover Size: 7.09" x 11.02" (18x28cm)



FLEXIBLE PVC WASH BRUSH

ITEM NO. MS-PWB01

Pole length 1.2m, extends to 2.4m

Material: Aluminum+PVC

Designed for cars, trucks, SUVs, RVs, All the floors, walls and Ceilings



Premium Detailing Extension Microfiber IncrediStick

ITEM NO. MS-FCB02 Series

Pole length: 63cm Pole Length Extended: 120cm Length with Mitt Head: 138cm

Mitt Head Dimensions: 26x13cm Plate Size: 23 x 11.4cm Pole and Plate Material: High Strength Aluminum

Package includes: 1pc extendable incrediStick, 1pc grey chenille headcover, 1pc red and white microfiber headcover



FCB02-HRW
Microfiber & Thin Sponge



FCB02-HBK
Scrub Fabric & Sponge



FCB02-HG
Chenille & Thin Sponge



FCB02-HBL
Soft Plush Microfiber
& Sponge



FCB02-HY
Mesh Sponge



SOFT BRISTLE BRUSH HEAD



ITEM NO. MS-BH-BS
 Bristle Material: PET & PBT
 Base Material: Beechwood
 6.7 x 3.1in/17 x 8cm



ITEM NO. MS-BH-BL
 Bristle Material: PET & PBT
 Base Material: Beechwood
 9.8 x 3.1in/25 x 8cm

STIFF BRISTLE BRUSH HEAD



ITEM NO. MS-BH-WS
 Bristle Material: PBT
 Base Material: Beechwood
 6.7 x 3.1in/17 x 8cm



ITEM NO. MS-BH-WL
 Bristle Material: PBT
 Base Material: Beechwood
 9.8 x 3.1in/25 x 8cm

MEDIUM BRISTLE BRUSH HEAD



ITEM NO. MS-BH-YS
 Bristle Material: PP
 Base Material: Beechwood
 6.7 x 3.1in/17 x 8cm



ITEM NO. MS-BH-YL
 Bristle Material: PP
 Base Material: Beechwood
 9.8 x 3.1in/25 x 8cm

CLASSIC SOFT BRUSH HEAD



ITEM NO. MS-BH-RS
 Bristle Material: PET & PBT
 Base Material: Beechwood
 6.7 x 3.1in/17 x 8cm



ITEM NO. MS-BH-RL
 Bristle Material: PET & PBT
 Base Material: Beechwood
 9.8 x 3.1in/25 x 8cm

TELESCOPING HANDLE FOR Cleaning BRUSH

- Telescopic Aluminum Handle: Adjust the 3-section pole to your desired length for flexible cleaning in various situations.
- Ergonomic Comfort Grip: Enjoy a secure and comfortable hold, reducing hand fatigue during extended cleaning sessions.
- Lightweight and Portable: Easily transport and store the handle, making it convenient for on-the-go cleaning tasks.
- Versatile Compatibility: Pair with MaxShine Brush Heads to customize your cleaning for detailed work or large surface areas.
- Extended Reach: Effortlessly clean hard-to-reach areas on boats, RVs, and home exteriors, ensuring a thorough clean every time.

ITEM NO. MS-TH-6
 Extension Length: 4-6ft
 Material: High Strength Aluminum

ITEM NO. MS-TH-9
 Extension Length: 4-9ft
 Material: High Strength Aluminum

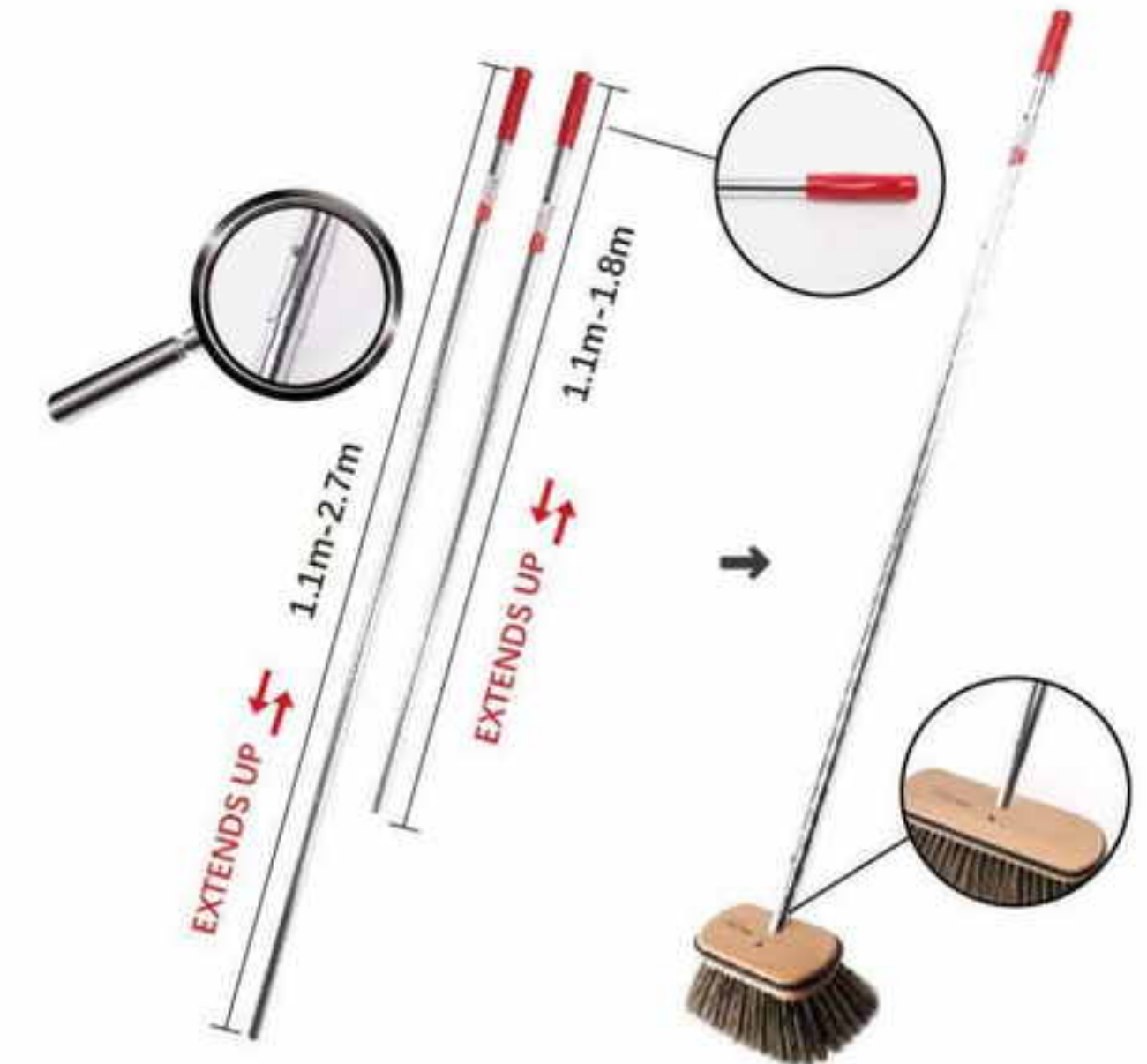

CLAY PRODUCTS SERIES



Maxshine Clay has become a really popular component to car enthusiast's culture, as it removes the increasing damage being done to the finishes of today's vehicle due to harsh pollutants that burn right through conventional protectants.



CLAY TOWEL

- **Customizable hollow-logo:** Place your logo anywhere.
- **Multiple colors & sizes:** Perfect fit for any need.
- **Back customization:** Printed or embossed logos and patterns.
- **Tailored texture pattern :** Unique designs for every towel.
- **Versatile edges & back:** Cut, hemmed, printed or embossed.



ITEM NO. MS-MCT3030-V4
Size: 30x32cm(Customized)



ITEM NO. MS-MCT3030-V3
Size: 30x32cm(Customized)



ITEM NO. MS-MCT3030-V2
Size: 30x30cm



ITEM NO. MS-MCT3030
Size: 30x30cm



CLAY PAD

- **Customizable hollow-logo:** Place your logo anywhere.
- **Tailored texture pattern:** Unique designs for every clay pad.
- **Back customization:** Printed or embossed logos and patterns.
- **Multiple colors & sizes:** Perfect fit for any need.



ITEM NO. MS-CP150 Ø 150x13mm (6")
ITEM NO. MS-CP125 Ø 125x13mm (5")
ITEM NO. MS-CP80 Ø 80x13mm (3")

ITEM NO. MS-CP80-V4 Ø 80x13mm (3")
ITEM NO. MS-CP125-V4 Ø 125x13mm (5")
ITEM NO. MS-CP150-V4 Ø 150x13mm (6")



ITEM NO. MS-CP150-V2 Ø 150x13mm (6")
ITEM NO. MS-CP125-V2 Ø 125x13mm (5")
ITEM NO. MS-CP80-V2 Ø 80x13mm (3")



CLAY SPONGE BLOCK

- **Tailored texture pattern:** Unique designs for every sponge.
- **Customizable hollow-logo:** Place your logo anywhere.
- **Multiple colors & sizes:** Perfect fit for any need.
- **Back customization:** Printed or embossed logos and patterns.



ITEM NO. MS-MCB04
Size: 11x7x4cm



ITEM NO. MS-MCA01
Size: 10.5x6cm



ITEM NO. MS-MCB02
Size: 11.2x6.2x3cm



ITEM NO. MS-MCB03
Size: 11x7x4.5cm



CLAY MITT

Tailored texture pattern:

Unique designs for every clay pad.

Multiple colors & sizes: Perfect fit for any need.

Customizable logo: Provides excellent durability and customizable embroidered logo.

Back customization: Custom towel colors, structures & materials for your exclusive mitt combinations.



ITEM NO. MS-MCM04
Size: 26x16cm



ITEM NO. MS-MCM06
Size: 21x16cm



ITEM NO. MS-MCM02
Size: 30x11-18cm



ITEM NO. MS-MCM01
Size: 22x14cm



ITEM NO. MS-MCM03
Size: 22x14cm



ITEM NO. MS-MCM05
Size: 21.6x15.5cm



PREMIUM CLAY SPONGE



ITEM NO. MS-MCB05

Size: 16x9x4cm Material: 80/20 Microfiber+Clay

- Tailored texture pattern:** Unique designs for every sponge.
- Multiple colors & sizes:** Perfect fit for any need.
- Customizable hollow-logo:** Place your logo anywhere.
- Back customization:** Different materials combinations can be sewn together, e.g., long-pile car wash towel+clay surface..



Microfiber Clay Block Wash Pad

ITEM NO. MS-MCB06

Size: 12.6 x 7.28in / 32 x 18.5cm Material: Sponge, Clay, and Microfiber



The microfiber flexible edge allows the clay to comply with all the vehicle's.



CLAY BAR



- ITEM NO. MS-CB50** 50g
- ITEM NO. MS-CB100** 100g
- ITEM NO. MS-CB150** 150g
- ITEM NO. MS-CB200** 200g

Hand Clay Bar Pad Auto Car Wash Body



ITEM NO. MS-HCP01

Size: 13 cm Material: Clay Type: Paint Cleaner

SNOW FOAM

LANCE

Maxshine is professional manufacturer of Snow Foam Lance, we have kinds of different sharp snow foam lance for options, Maxshine Quality design and fittings provide excellent durability for everyday usage. Maximum Pressure 160 Bar. Max Temp 60 Degrees
Maxshine snow foam lance works with a pressure washer to produce a thick, clinging foam.
Give your vehicle a "touch-free" wash with this high powered foam gun.
Complete with your choice of connector.
(Karcher, Alto, Lavor, M22, Bosch and Karcher HDS Fix Fitting...etc)



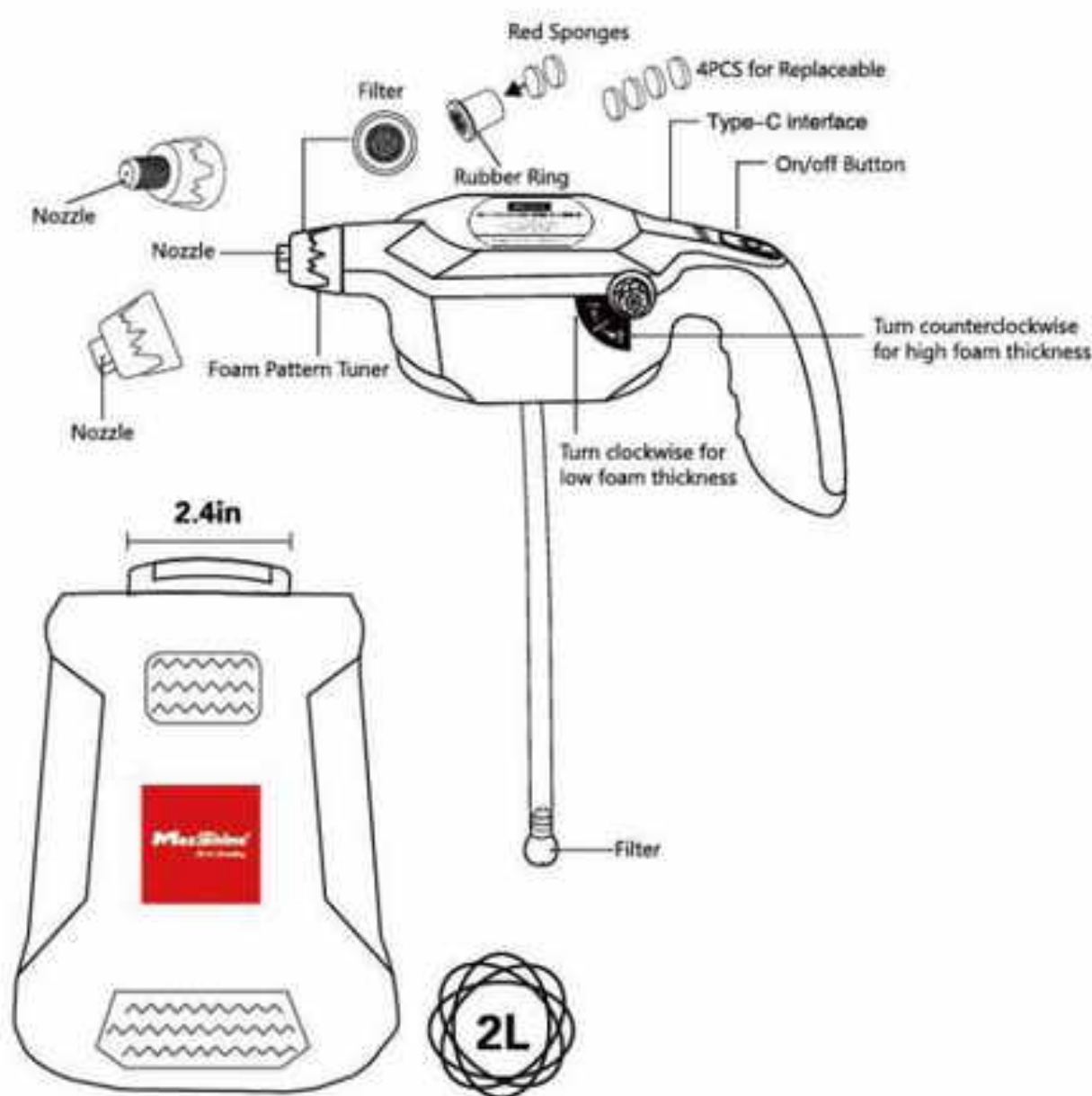

Cordless Electric Sprayer & Foamer

ITEM NO. MS-P05
 Size: 27(L) x 13(W) x 26(H)cm, 0.8kg
 Charger: 5V/800MA(Type -C cable)
 Li-ion Battery: 7.4Vdc/2600mAh
 2L(70oz) Reservoir
 1PC Thin Foam Nozzle & 1PC Thick Foam Nozzle
 1PC Spray Nozzle



Snow Master Foam Cannon V2

ITEM NO. MS-FL10 Capacity: 1L(35oz) Maximum Pressure: 200BAR / 3000PSI
 Requires Pressure: 70BAR / 1000PSI
 Size and Weight: 6.65in (L) x 4.29in (W) x 10.63in (H), 1.52lbs
 Material: Heavy-duty PET Clear Bottle With Moulded Grip



Snow Master Foam Gun V2
ITEM NO. MS-MFG01

Capacity: 1L(35oz)
Size and Weight: 15.63in (L) x 4.29in (W) x 9.33in (H), 1.54lbs
Material: PET + Stainless Steel Bottle: High Transparent PET



Pressure Washer Wand

ITEM NO. MS-HWG-EP
Size: 50.8x4cm
Water Inlet: 3/8" quick disconnect plug
Water Outlet: 1/4" quick disconnect coupler
Max: 280 bar/4000psi
Material: Stainless Steel + 20% reinforced PP



Pressure Washer Gun Pro

ITEM NO. MS-HWG02
Water Inlet: 3/8" quick disconnect plug
Water Outlet: 1/4" quick disconnect coupler
Max: 5000 PSI (350 bar)
Max: 12 US gal/min (45L/min)
Max: 300°F(150°C)
Equipped with 2 Nozzles 15° & 40°



Foam Wash Gun

ITEM NO. MS-FWG01
 Material: PP, ABS Body
 with copper connector
 Cup Volume: 1 L
 Water Pressure: 40-90PSI
 Ratio: 5 ratio settings to suit your needs



Snow Foam Cannon

ITEM NO. MS-FL02
 Material: PP with copper connector
 Cup Volume: 1 L
 Complete with your choice of connectors,
 such as Karcher K, Alto, Bosch, Lavor, M22, Karcher HD. etc.



Low Pressure Car Washing Foam Gun

ITEM NO. MS-FWG03
 Material: PE + Zinc alloy (inside gun handle) + Brass connector
 Cup Volume: 1 L
 Water Inlet Connection:
 Garden water pipe nipple, copper quick connection
 Min Pressure: 36 PSI Max Pressure: 87 PSI
 Max Temperature: 40° C
 Nozzle Dia: 1.9mm



Short Wand High Pressure Washer Gun

ITEM NO. MS-HWG01
 Maximum pressure: 5000 PSI
 Nozzles Tips: 3 Pressure Power Washer Nozzles Tips
 Plug: M22 14 Swivel 3/8" Plug



Snow Master Foam Cannon

ITEM NO. MS-FL06
 Cup Volume: 35oz(1000ml) Inlet: 1/4" F
 Minimum Pressure: 870 PSI Nozzle Diameter: 1-1/4"
 Minimum Flow: 1.3 GPM Maximum Temperature: 140° F
 Maximum Pressure: 3,190 PSI Maximum Flow: 5.3GPM



Snow Foam Lance

ITEM NO. MS-FL01
 Material: PP with copper connector
 Cup Volume: 1 L





1L Transparent Snow Master Foam Cannon

ITEM NO. MS-FL05

Material: PP with copper connector

Cup Volume: 1 L

Adjustable Spray Pattern with 360-degree Adjustment.

Suitable for a wide range of Pressure Washer Units on the Market.



New Pressure Washer Nozzles

ITEM NO. PWN01

Hole Diameter: 1.2mm (040)

Material: Plastic + Stainless

Color: Red, Yellow, Green, White

Working pressure: 100 bar–200bar(1450psi–3000psi) Max temp 60 Celsius

Package Content:

4 x Tip (1 x Red Tip (0 Degree)+1 x Yellow Tip (15 Degree)+1 x Green Tip (25 Degree)+1 x White Tip (40 Degree)



Foam Cannon High Performance Foam Sprayer For Car Detailing

ITEM NO. MS-FL09

Material: PE.HD with copper Cup Volume: 1000 ML Color: Black



ADJUST ABLE SOAP CONCENTRATION

ADVANCED AIRATION SYSTEM

STAINLESS STEEL 1/4 INCH QUICK CONNECT ADAPTOR

1.1 MM ORIFICE

46 MM WIDE BOTTLE KNECK

ADJUSTABLE SPRAY RADIUS

1000 ML CAPACITY

2 grooves on the two side for easy opening of the foam cannon cap



Premium Stainless Steel Spray Nozzle Set

ITEM NO. PSN01

Orifice Size: 1.0 Material: Stainless Steel

Connection: 1/4-inch Quick Release Fitting

Dimensions and Weight: 4.5 x 4.5 x 7.3 cm, 0.08kg(1pc)



Red Nozzle
15°

Green Nozzle
25°

Orange Nozzle
40°



1.5L Manual Pressure Sprayer

ITEM NO. MS-P04

Material: PP with copper connector

Cup Volume: 1.5 L

Hand-held pump sprayer used for car care, home and industrial cleaning.

Suitable for foam spray



Foam & Wash 2-In-1 System

ITEM NO. FWS01

Size: 26.5 (L) x 2.3(W) x 8.7 (H) cm, 0.34kg

Max Pressure: 5000psi

Max Temperature: 60°

Connection: 1 / 4 Inch Quick Connect

Material: Stainless-Steel

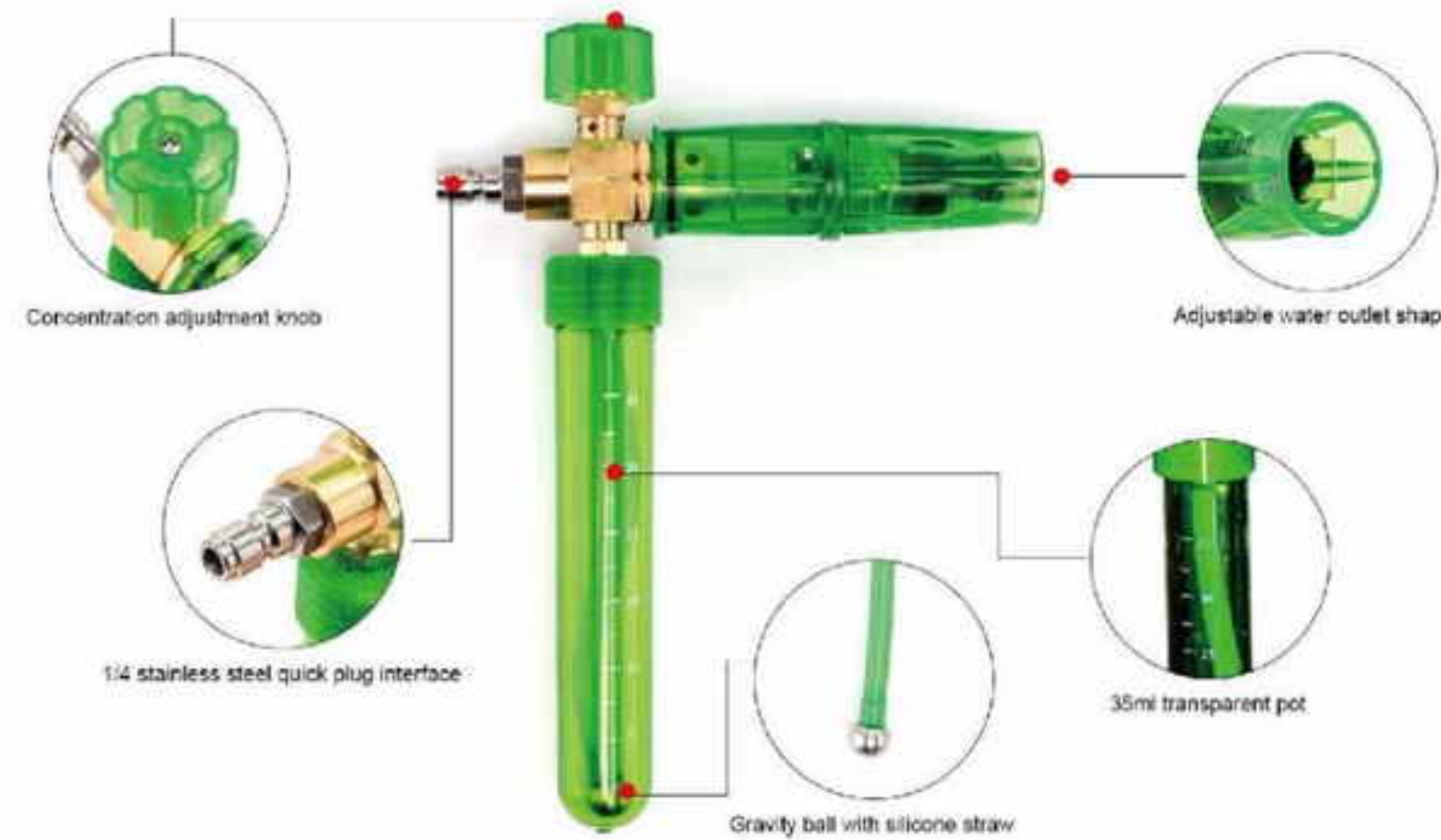

High Pressure Wash Gun Foam Concentrate Pot

ITEM NO. MS-HFC01

Material: Plastic/Copper+PET bottle

Green silicone gravity ball straw

Volume: 35ml

Copper orifice size: 1.25

Comes with 1/4" quick-connect plug



Handheld 1.5L Pressure Sprayer

ITEM NO. FL08-1 / ITEM NO. FL08-2

Sprayer Type: Handheld

Capacity: 1.5L (50oz)

Max Working Pressure: 3 Bar (43.5 PSI)

2 Styles For Customers to Choose(Bottle)

Package Including:

Pressure Sprayer+Foam Sprinkler+Chemical Spray Nozzle+Shim



MaxShine®

MaxShine®

MaxShine
MIO
CLEANER
WAXING CLEANER

MaxShine®

MaxShine®

MaxShine®

TORNADOR
CLEANING
GUN



ITEM NO. MS-TCG01
 Size: 24*32cm
 Air Pressure: 0.4 to 0.8 MPa
 Air Flow Rate: 260 L/min at 0.5 MPa
 Cup Volume: 1 L



ITEM NO. MS-TCG02
 Size: 23*35cm
 Air Pressure: 0.4 to 0.8 MPa
 Air Flow Rate: 260 L/min at 0.5 MPa
 Cup Volume: 1 L



ITEM NO. MS-TCG03
 Size: 25*41cm
 Air Pressure: 0.4 to 0.8 MPa
 Air Flow Rate: 260 L/min at 0.5 MPa
 Cup Volume: 1 L



Multi-function Tornador

ITEM NO. MS-MT01
 Size: 16x34cm
 Air Pressure: 0.4 to 0.8 MPa
 Air Flow Rate: 160 L/min at 0.5 MPa



Water Cannon Multifunction Spray Gun 8 Settings Built In Soap Dispenser

ITEM NO. MS-WCG01
 Size: 43x15x5cm
 Material: ABS Plastic
 Garden Water Gun Type: Sprayer



Tornador Mini Air Powered Cleaning Tool

ITEM NO. MS-DR04
 Size: 20.5x4.5x4cm
 Air Consumption: 226.56 L/m
 Air Inlet: 1/4"
 Air Pressure: 90 PSI (6.3 bar)
 Weight: 0.15 kg



Drying Tornador

ITEM NO. MS-DT01
 Size: 18x30cm
 Air Pressure: 0.4 to 0.8 MPa
 Air Flow Rate: 160 L/min at 0.5 MPa



Dirt Remover

ITEM NO. MS-DR01
 Size: 20x27cm
 Air Pressure: 0.4 to 0.8 MPa
 Air Flow Rate: 160 L/min at 0.5 MPa



Engine Tornador

ITEM NO. MS-ET01
 Size: 16x53cm
 Air Pressure: 0.4 to 0.8 MPa
 Air Flow Rate: 160 L/min at 0.5 MPa



Car Tornado Dust Blower Cleaning Gun

ITEM NO. MS-DR03

Size: 20x3x15cm Product Weight: 0.26kgs
 Air Consumption: 120L-160L/min
 Pressure: 7bar
 Material: Steel
 Air outlet connect: EU, US or Japanese



Tornado Car Cleaning Gun Air Blow Dust

ITEM NO. MS-TCG04

Size: 30x5x23cm Product Weight: 0.46kgs
 Free Rotation Speed: 6000RPM
 Air Consumption: 120L-160L/min Pressure: 7bar
 Liquid Consumption: 3L-3.7L/hr
 Air outlet connect: EU, US or Japanese



High Pressure Air Pulse Car Cleaning Gun

ITEM NO. MS-TCG05

Size: 69x13x23cm
 Product Weight: 0.9kgs
 Air Consumption: 120L-160L/min
 Liquid Consumption: 3L-4L/hr Pressure: 7bar
 Air outlet connect: EU, US or Japanese



Clean Interior & Exterior Surfaces With Tornado Air

ITEM NO. MS-TCG06

Size: 32x13x23cm Product Weight: 0.7kgs
 Free Rotation Speed: 8000RPM
 Air Consumption: 120L-160L/min Pressure: 7bar
 Liquid Consumption: 3L-3.7L/hr
 Air outlet connect: EU, US or Japanese



High Pressure Car Interior Spraying Washing Gun With 2 Set Nozzle

ITEM NO. MS-DR02

Product Weight: 0.4kgs
 Free Rotation Speed: 8000RPM
 Air Consumption: 120L-160L/min
 Pressure: 7bar
 Air outlet connect: EU, US or Japanese

DETAILING SPRAYER



Heavy Duty Chemical Resistant Trigger Sprayer

ITEM NO. MS-FL07

Capacity: 750ml / 25oz

Trigger: Made in Taiwan, China.

Bottle: Made in China.

Color: Customizable



Heavy -Duty Trigger Sprayer

ITEM NO. MS-TG01

Material: PP and Copper

Total capacity: 700ml



Heavy -Duty Trigger Sprayer

ITEM NO. MS-TSN01

Fits 32oz bottles you can cut the dip tube

to fit 24oz and 16oz bottle

Dip Tube Length 19cm

Closure: 28/410



DETAILING TOOL BAG

Carry your DA/RO polishers, pads, and polishes, microfiber cloths, waxes from the garage to the car club or concours event in this Maxshine Detailing tool Bag. The Maxshine Detailing tool bag is built with detailers in mind. It has a place for everything! Store your DA Polishers, buffing pads, swirl removers, waxes, and brushes. ...etc Compartmentalized storage space keeps everything organized and easy to find.



Detailing Tool Bag -600D Oxford Fabric

ITEM NO. MS-DB4

Size: 45x25x30cm

Material:600D

Quality Stripes for Fasten the machine





Detailing Tote Bag -1680D Oxford Fabric

ITEM NO. MS-DB10

Size: 32x21x25cm

Material: Polyester fiber





ITEM NO. MS-DB9
Size: 50x26x22cm
Material: 1680D



ITEM NO. MS-DB7
Size: 24x19x22cm
Material: 1680D



ITEM NO. MS-DB11
Size: 25x20x23cm
Material: Polyester fiber



ITEM NO. MS-DB8
Size: 29x24x24cm
Material: 1680D



ITEM NO. MS-DB12
Size: 35x27x29cm
Material: Polyester fiber



Quick Load Detailing Caddy & Storage Organizer Bag

ITEM NO. MS-DB1

Size: 49x25.5x30cm (no cover)
Material:600D



Quick Load Detailing Caddy Bag with Cover

ITEM NO. MS-DB1-C

Size: 49x25.5x30cm (with cover)
Material:600D



Detailers Bag with Storage Organizer

ITEM NO. MS-DB3

Size: 42.5x24x34cm
Material:600D



DETAILING BELT

ITEM NO. MS-DBT01

Including 5 small pockets ,1 belt
Flexible Combination
Perfect for detailing

FOAM WAXING APPLICATOR

Maxshine offer kinds of different material waxing applicators. Maxshine innovative combination of materials causes wax, polish, interior and exterior dressings, and sealants to spread more evenly, resulting in maximum coverage while using less product. Super soft and perfect cleaning ability, more durable and environmentally friendly, only work with water and without chemical, easy cleaning for car.





Dressing & Protectant Applicator

ITEM NO. MS-FA-4B

Size: 12x5.5x7cm

Colour: Black / Blue / Red / Yellow / Gray

Color can be customized

Material: Sponge / PP



Tire Dressing Applicator With Cover

ITEM NO. MS-FA-41

Size: 3.56 in x 4.79 in Material: ABS+Sponge



Tire Foam Applicator

ITEM NO. MS-FA-19

Size: 8.3x9.5x(2.5+3.5)cm

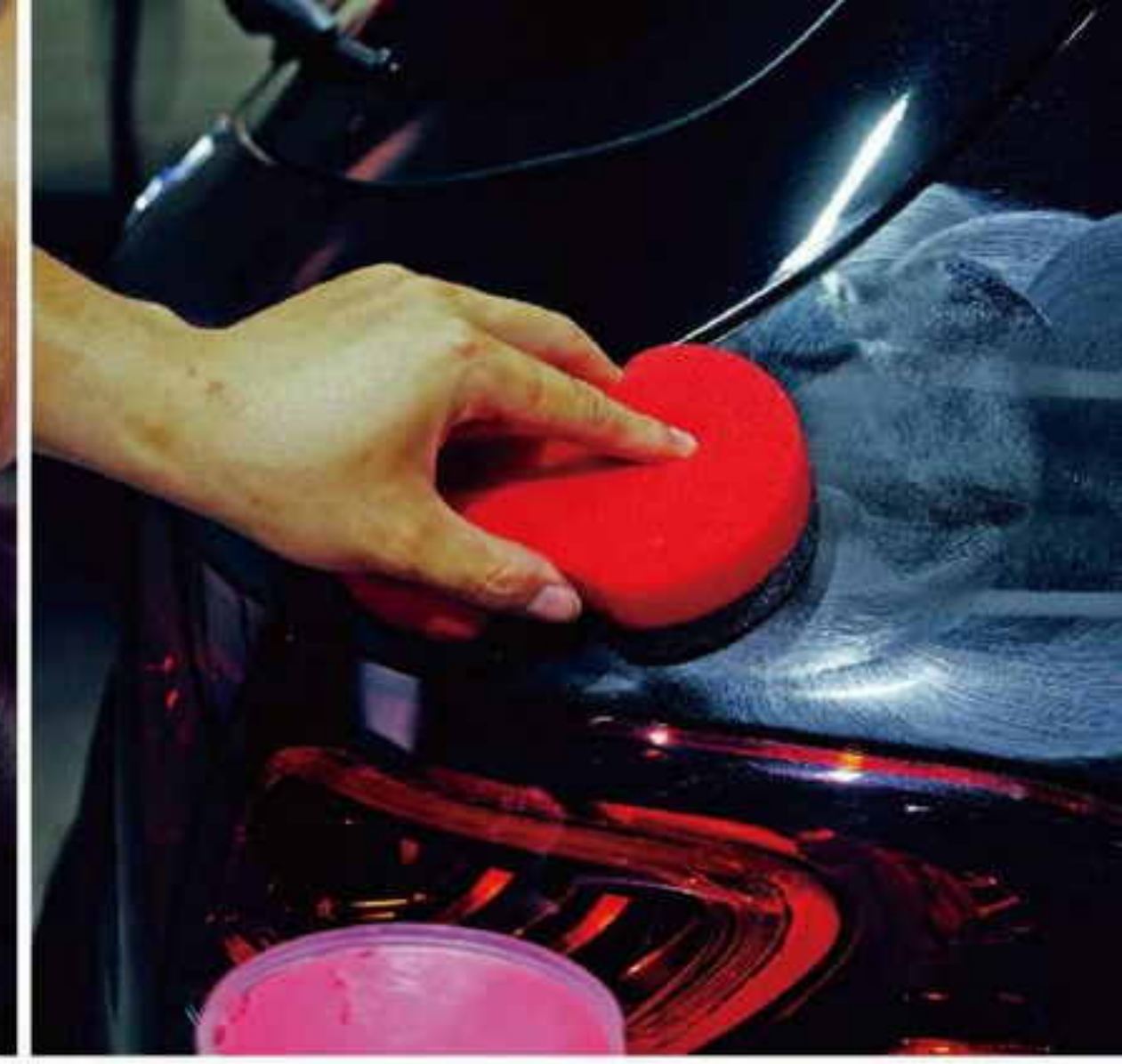

ITEM NO. MS-FA-4 Size: 10x4x(2.5+3.5)cm



ITEM NO. MS-FA-35 Size: \varnothing 10x1.5cm



ITEM NO. MS-FA-22 Size: 10x5.5x4cm



ITEM NO. MS-FA-23 \varnothing 11x4.5cm



ITEM NO. MS-FA-15
Size: 15.5x9.2x(1.2+1.2+1.2)cm



ITEM NO. MS-FA-34 Size: 9.5x4x(3+3.5)cm

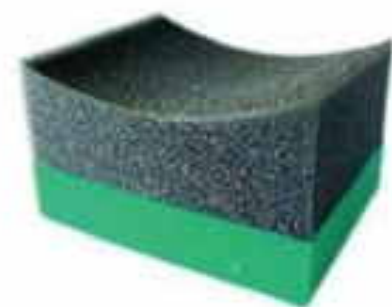

ITEM NO. MS-FA-33 Size: 10x8x(2+4)cm



ITEM NO. MS-FA-14
Size: 15.5x10x(1+2)cm



ITEM NO. MS-FA-31
Size: 16x8x3.5cm



ITEM NO. MS-FA-32
Size: \varnothing 10.5x6cm (large) \varnothing 6.5x6cm (small)



ITEM NO. MS-FA-11
Size: 7.4x(1.2+1.5)cm



ITEM NO. MS-FA-37 Size: 8.5x4x4cm



Tapered Foam Applicator
ITEM NO. MS-FA-12 Ø 10x2.5cm



ITEM NO. MS-FA-1 Ø 10.5x2cm



ITEM NO. MS-FA-2 Ø 10.5x2cm



Finger Foam Applicator
ITEM NO. MS-FA-3 Size: 12x8cm



ITEM NO. MS-FA-40 Size: 6.6x3.7x(3+3)cm
Colour: Blue/Gray



ITEM NO. MS-FA-38
Size: 13.5x9.5x4.5cm



Coating Applicator
ITEM NO. MS-FA-5 Size: 10x4.6x(1.5+5)cm



Plush Microfiber Applicator
ITEM NO. MS-FA-7 Ø13x2cm



Terry Microfiber Applicator
ITEM NO. MS-FA-6 Ø13x2cm



ITEM NO. MS-FA-20 Ø13.5x2.5cm



ITEM NO. MS-FA-21
Size: 12x15.5x5cm



ITEM NO. MS-FA-25
Size: 16x10x4.5cm



ITEM NO. MS-FA-27
Size: 15x10cm



ITEM NO. MS-FA-36
Ø85x10 mm



ITEM NO. MS-WAX-A
Ø72mm PU Block
Ø75mm Orange/Blue/Yellow Applicator
Ø75mm Black/White Applicator



ITEM NO. MS-FA-39
Size: 12x8.5cm
Material: Microfiber+Sponge



DETAILING ACCESSORIES

Make things easy by yourself and get the right tools!
You've already spent enough on your waxes and polishes, you might as well get the right accessories to properly clean and protect your car. We have sourced the finest range of accessories that compliment the entire car cleaning process.





Heavy Duty Ultra Clear Detailing Bucket

ITEM NO. MS-PB03 Transparent
 Volume:3.5 Gallon,Outside Dia.300mm,Height:280mm
 Volume:5 Gallon,Outside Dia.300mm,Height:385mm



Work Gloves Breathable

ITEM NO. MS-WGB01
 Item Dimensions: S/M/L/XL/XXL
 Material: Polyester / Carbon Fiber / Nitrile Scrub



Bucket Caddy

ITEM NO. MS-BB01
 Size: 34x15x22.2mm Material: PP
 Brush slots: 14mm & 18mm
 Color: Black & Red



Bucket Caddy

ITEM NO. MS-BB01-T
 Size: 34x15x22.2mm Material: HDPE
 Brush slots: 14mm & 18mm
 Color: Transparent



Sand Killer With Washboard Insert

ITEM NO. MS-GG02

Size: 26.4 (L) x 26.4(W) x 5.3(H) cm
 Weight: 0.51kg Material: PP&Fiberglass
 Fits most 3.5-5 gallon buckets

Pad Cleaning Tools

ITEM NO. MS-PSR

Perfect For Cleaning Wool/Foam Pads
 Buffing Polishing Pad Cleaning Tools
 Buffing&Polishing Pad ,Wool Polishing Pad Cleaning Spur



Folding Wash Bucket

ITEM NO. MS-FWB01

Volume: 2-20L Material: 600D

ITEM NO. MS-PB02

3.5 Gallon or 5 Gallon



Cross Bucket Lid

ITEM NO. MS-CBL01

Volume: 20L Size: Ø305mm Material: PP

Volume: 13L Size: Ø300mm Material: PP





Multifunction Bucket Lid Seat with Soft Foam

ITEM NO. MS-MBL01

Dimension: 35.2x31.2x3.5cm

Material: Hard plastic & Sponge

Color: Black & Red



Detailing Kneeling Pad

ITEM NO. MS-KP01

Material: EVA Foam Size: 18" x11" x1.6"





Silicone Soft Water Blade
With Anti-Slip Handle-3 Layer Lips

ITEM NO. MS-SWB04
Length: 11" x 3.2"
Material: 100% Silicone And Rubber



Ezy Wheel Hose Slide Rollers

ITEM NO. MS-EZW01
Color: Red
Material: Plastic



MODULAR DETAILING CREEPER

New Creeper II with Soft Cushion

ITEM NO. MS-NC02

Dimensions: 95cm x 40cm x 36cm (with additional bottle holders)

Holds: 6 bottles (4-22oz max) with additional holders attached



New Creeper II
ITEM NO. MS-NC01



Modular Detailing Creeper
Bottle holder, set of 2

ITEM NO. MS-NC01



Mini Creeper



ITEM NO. MS-MC01

Dimensions: 47 x 26 x 11cm

Material: PPT30



ITEM NO. MS-SRC01

Dimensions: 48 x 28 x 6cm

Material: Soft rubber polyether



Premium Detailing Rolling Chair

ITEM NO. MS-DRC04

Height: Adjustable 17.72" to 25.59"

Weight Capacity: 400 lbs Color: Black / Red

Cushion Size: 14.17" x 4.72"

Casters: 4" Industrial Casters with 2 Brakes

Material: Iron, Stainless Steel, Leather, and Sponge

Optional Iron Tool Tray to keep tools close at hand

Tool Tray: (Sold Separately)

22.83" x 22.83" x 0.94"

Material: Iron



ITEM NO. MS-DRC01

Material: Steel+PU+Sponge

Min. Height: 415mm

Max. Height: 550mm



ITEM NO. DRC02

Material: Steel+PU+PP

Size: 73cmx63cm



Folding Detailing Cart



New Premium Steel Detailing Rolling Trolley II



ITEM NO. MS-DRL06
 Material: PP & Steel
 Size: 74cm(H) x 66cm(L) x 40cm(W)
 The fold length is 16cm.



ITEM NO. MS-DRL05
 Material: High Quality Steel Size: 97.9x50.3x90.35cm

- Three 16oz (Dia:70mm) and three 32oz (Dia:89mm) bottle holders
- Two Curved Grip XL Brush holders (Dia:62mm).
- One Snow Master Foam Cannon V2 holder (Dia:122mm)
- Two small chemical holder (Dia:43mm)
- Four detailing brush holders (Dia:20-31mm)
- Two polisher & one mini polisher holders
- 4" Swivel Rubber Wheels, Dual Locking, Dual Bearing, 360 Degree Rotation



Premium Heavy Duty Detailing Cart



ITEM NO. MS-DRL04 Material: PP Color: Red+Black Size: 90.25x46x86cm



ITEM NO. MS-DRL02
Material: PP
Overall Dimensions: 97x88x48cm
Hook: Small 24 pcs, Large 2pcs



ITEM NO. MS-DRL03
Material: Steel
Size: 50x80x40cm



ITEM NO. MS-ES50 LENGTH: 50mm
 ITEM NO. MS-ES80 LENGTH: 80mm
 ITEM NO. MS-ES120 LENGTH: 120mm
 THREAD: M14/ 5/8"

Measuring Cup

ITEM NO. MS-MSC01

Volume: 100ml or 3.2oz

Package including: Measuring cup and Matching straws

2 styles to choice:

1. Cut straws to suitable length according to bottle requirements, 500ml or 1000ml
2. The straw is nested up and down, and the length can be adjusted by yourself, 500ml or 1000ml



Wheel Cover

ITEM NO. MS-WHC01

Fits wheels up to 22" in diameter,
 oxford cloth fabric coated with PU



Detailing Swabs

ITEM NO. MS-DS01

- Long-Reach Microfiber Overall Length: 165mm
- Large Square Foam Overall Length: 125mm
- Large Square Microfiber Overall Length: 125mm
- Dual-Head Microfiber Overall Length: 92mm
- Fine-Point Foam Overall Length: 76mm





Coating Thickness Gauges

ITEM NO. MS-CTG01

Size / Weight / Case material: 114mmX53mmX25mm / 80g / ABS
 Measuring Range: 0-2000 μm

Measuring Principle: Fe: Magnetic induction NFe: Eddy currents
 Including:

1. Coating Thickness Gauge packing with a plastic box .
2. USB Cable
3. Calibration materials
4. User manual
5. A CD for APP download

note: need work with two 1.5V AAA batteries
 (need customer buy by themselves)



Coating Thickness Gauge

ITEM NO. MS-CTG02

Size: 70.30*38.6*149.59 mm / 2.7*1.5*5.88 inch Weight: 100 grams
 Measuring Range: 0-1500 μm / 0-59mil / 0-1.5mm
 Minimum Thickness Of Metal Substrat: 0.5mm

Packing List:

1. Coating Thickness Gauge with internal F/NF probe
2. Battery charger (Type A plug socket) and USB charging cable
3. Ferrous substrate
4. Non-ferrous substrate
5. Standard foils (6 pcs)
6. User Manual in English
7. Hard Carrying case

note: need work with two 1.5V AAA batteries
 (need customer buy by themselves)



Digital Coating Thickness Gauge

ITEM NO. MS-CTG03

Size: 62x27x121.5mm
 Measuring Range: 0-1800 μm / 70.8mil / 1.8mm
 Minimum Thickness Of Metal Substrat: 0.5mm
 Operating Humidity: 10-95% RH

Competitive paint depth gauge is designed for 0-1800 μm thickness measurement. The paint thickness gauge has zero calibration, two-point calibration and basic calibration. Coating thickness gauge is highly accurate and compact tester, which comes with 0.05mm/2mil resolution car mode and 0.01mm/1mil resolution user modes.

note: need work with two 1.5V AAA batteries
 (need customer buy by themselves)



MINI HANDHELD CAR DRYER

ITEM NO.	Power	Volume	Cord Length	Rated Frequency	Horsepower
MS-MHD01	110-240V, 1200W	22000FPM, 90CFM	6m(20ft)	50-60Hz	1.5HP

Included: 2 nozzles available

Mini handheld car dryer may be light and compact, but it has strong impact.



Air Filter

Filter the air and thicken the filter element to avoid sucking some dust particles into the motor.



Contactless Drying

Stops marring & swirls

20ft / 6m
Professional Cord

- The efficient 1.5HP motor increases air temperature, up to 25 degrees above ambient temperature, which provides faster drying.
- It's filtered air is ideal for delicate surfaces like paint, chrome, and plastics.
- The ergonomic handle optimizes reaching every area in any orientation.
- Perfect for removing water out of all the hard-to-reach places like grilles, bumpers, vents, and wheels.
- More efficient and powerful, while remaining light weight.

Mini Handheld Dryer may be light and compact, but it packs a big punch. Ideal for safely and easily drying every bit of a vehicle, it comes with a handy 20ft/ 6M Cord and a choice of 2 nozzles to suit any job.



TWINS MOTOR TOUCHLESS CAR DRYER



Meet the Twins Motor Touchless Car Dryer, the ultimate car dryer boasting twin motors generating 8.5HP power. This powerhouse swiftly blasts water off surfaces, ensuring a quicker, scratch-free dry compared to traditional methods. With over 65,000 FPM at peak power and a variable dial for control, it offers rapid drying while maintaining safety for delicate areas. Its swiveling wheelbase, safe lock system, and an extensive 26ft hose ensure easy maneuverability and comprehensive coverage for cars, bikes, boats, and more. Mount it effortlessly with the customer optional wall bracket, keeping the blower ready for action. Experience the evolution in drying—Twins Motor Touchless Car Dryer delivers power, precision, and convenience for a flawless finish, 80% faster than standard methods.

ITEM NO.	Voltage	Power	Air flow	Power cable length	Hose length	Style
MS-CDB01	110-240V/50-60Hz	2400W	65000FPM	20ft/6m	26ft/8m	General
MS-CDB01 V2	110-240V/50-60Hz	2400W	65000FPM	20ft/6m	26ft/8m	Upgraded with Remote Control

8.5HP via twin motors Variable Air Speed Control
Customized Twin Motor Touchless Car Dryer or V2 with Remote Control can optional

Dimensions: 15.55(L) x 11.99(W) x 8.39(H) in 39.5(L) x 30.45(W) x 21.3(H) cm

FEATURES



01

Two silencing inner barrels and Powerful Twin Motors
 Dries engines and components quickly to help prevent corrosion. Reduce noise and fuselage failures built-in double-layer silencer filter cotton, sound insulate debris from entering the body, reduce body failure.



02

Its swiveling wheelbase, safe lock system, and an extensive 26ft hose ensure easy maneuverability and comprehensive coverage for cars, bikes, boats, and more.



03

Mount it effortlessly with the customer optional wall holder (Car dryer wall holder & Hose wall holder), keeping the blower ready for action.



Car Dryer Wall Mount

ITEM NO. MS-CH10

Package including: 2pcs/set

Dimension and weight:

6.49(L) x 6.16(W) x 0.65(H) in, 0.77lb

16.48(L) x 15.64(W) x 1.65(H) cm, 0.35kg



Hose Wall Holder for Car Dryer

ITEM NO. MS-CH11

Color: Black Painted Steel

Dimension and weight:

15.91 (L) x 13.74(W) x 2.3 (H) in

40.4 (L) x 34.9(W) x 5.85 (H) cm



SINGLE MOTOR TOUCHLESS CAR DRYER

Touchless drying prevents scratches and swirls.

Powerful single motors blast water away from surfaces, up to 80 times faster than traditional drying methods.

Forces water from smaller areas such as around side mirror housings, filler caps, wheel spokes, calipers, and nuts.

Dries engines and components quickly to help prevent corrosion.

Single Motor Touchless Car Dryer **with remote control** can be used to remotely adjust the wind speed and turn the machine on/off.



MS-CDS01



MS-CDS01 V2

Technical Data

ITEM NO.	Power	Air flow	Power cable length	Horsepower	Voltage	Style
MS-CDS01	2000W	45000FPM	6m(20ft)	5m(16ft)	110-240V/50-60Hz	General
MS-CDS01 V2	2000W	45000FPM	6m(20ft)	5m(16ft)	110-240V/50-60Hz	Upgraded with Remote Control

Customized Single Motor Touchless Car Dryer or V2 with Remote Control can optional

NOTE:

Hose wall holder optional

Car dryer wall holder optional

Hose wall holder and dryer wall holder not included



JETFORCE NANO CORDLESS DRYER

ITEM NO.	Max Wind Speed	Max Wind Pressure	Batteries Rated	Speed Regulation
MS-NCD01	163mph (73m/s)	3200 Pa	18V-21V	Continuously Variable Transmission

Includes: 5.0Ah Lithium-ion Battery & Charger; Completely Dry Any Car or Truck With 1 Battery Use
 15 Minute Run Time On Fully Charged Battery, with 1pc longer 52mm Orifice nozzle
 80,000 RPM And 163 MPH Of Pure Drying Power EU or US charger

- **Unrestricted Portability:** Cordless design allows you to effortlessly maneuver and clean hard-to-reach areas without being tethered by cords.
- **Exceptional Blowing Power:** Equipped with a high-speed brushless DC motor, this blower makes quick work of drying, dusting, and cleaning tasks.
- **Multi-Purpose Versatility:** An all-in-one solution for home, commercial, and outdoor use, it excels at everything from drying cars to clearing snow.
- **Ergonomic & Durable Design:** The lightweight and durable construction allows for comfortable, single-hand operation and long-lasting reliability.
- **Extended Battery Life:** Powered by rechargeable lithium-ion batteries, you'll enjoy extended run times and consistent power.



The JetForce Nano Cordless Dryer is the ultimate portable cleaning and drying solution! This lightweight, handheld blower boasts a high-speed brushless DC motor, delivering a powerful 163mph airflow and 1200G of thrust for unparalleled performance. Ideal for a wide range of tasks, from drying your car to clearing leaves, its cordless design and long-lasting, rechargeable lithium-ion battery make it perfect for both indoor and outdoor use.





MULTI-FUNCTIONAL HOLDER

Keep your within reach with a versatile storage organization. Enjoy a -free space and effortless access to your car detailing items. Stay organized and in control with a holder. Access your car detailing accessories whenever you need them, adding a of convenience to your detailing.





Polisher Holder

ITEM NO. MS-PH01

Size: 20x65x7.5cm

Material: Iron

Single Position



Hold For Small Polisher



Polisher Holder

ITEM NO. MS-PH05

Size: 16x13x7cm

Single Position



Polisher Holder

ITEM NO. MS-PH03

Size: 55x30x6.5cm

Material: Iron



Polisher Holder

ITEM NO. MS-PH04

Size: 55x31x7.5cm

Material: Iron



Polisher Holder

ITEM NO. MS-PH02

Size: 35x65x7.5cm

Material: Iron

Double Position



Hold For Small Polisher



Polisher Holder Single Position

ITEM NO. MS-PH06-S

Size: 33x22.5x7.5cm

Material: Iron



Polisher Holder Double Position

ITEM NO. MS-PH06-D

Size: 33x40x7.5cm

Material: Iron



Wheel Stand Pro



Wheel Stand Pro

ITEM NO. MS-MWS03

Color: Black

Material: Powder Coated Steel

Dimension and Weight:

17.72 x 14.57 x 4.72in, 11.4 lbs

45 x 37 x 12cm, 5.17kg

Shaft Length: 13.5in(34.5cm)

Distance between rollers: 26.85 - 37.15 cm



3-setting adjustable for any tire/rim detailing



Maxshine Wheel Stand

ITEM NO. MS-MWS01

Length: 58 cm Width from the wall: 34.5 cm

Height: 91.5 cm



Maxshine Extra Large Wheel Stand

ITEM NO. MS-MWS01 XL

Length: 58 cm Width from the wall: 53 cm

Height: 91.5 cm



Maxshine Wheel & Tire Detailing Stand

ITEM NO. MS-MWS01 R

Size: 91.5 X 58 X 34.5 cm

Weight: 12 kg Style: 3 pcs Red rollers Color: Black+Red



Wheel Stand With LED Light

ITEM NO. MS-MWS01-LED

Size: 58(L) x 36.5(W) x 91.5(H)cm

Color: Black with Red LED



**WALL MOUNTED FILM HANGER
- PPF AND VINYL 5 ROLL HOLDER**

ITEM NO. MS-WFH01

Hanger Dimensions: 110(H) x 15(W) cm

Steel Tube Dimensions: 164(L) x 2(W) cm

Material: Steel



Towel Holder Wall Mount

ITEM NO. MS-CH11

Dimensions: 31.3 x 10.6 x 9 cm

Material: Metal



Multifunctional holder

ITEM NO. MS-MH02
 Size: 41x6x52cm
 Material: Iron



Detailing Brush Holder

ITEM NO. MS-BH01
 Length: 41cm Width: 5cm
 Height: 5cm Hole Size: 2.5cm
 Material: Iron



Trigger Sprayer Holder

ITEM NO. MS-MH03
 Size: 50x5x2cm
 Material: Iron



Detailing Brush Hanger

ITEM NO. MS-MH05
 Length: 50cm Width: 4cm Hook mounts: 6 hooks
 Hook length: 5cm Hook width: 7mm Hook spacing: 9.2cm



Multifunctional holder

ITEM NO. MS-MH01
 Size: 50x4.8x5cm
 Slot size: \varnothing 9cm
 Material: Iron



Foam Cannon Wall Mount

ITEM NO. MS-MH06
 Size: 38.9x18cm Material: Iron
 Suitable For: 1/4" plug, 1/4" Quick Connect
 Connections: 3PCS Copper Connect



Snow Foam Lance Organizational Holder

ITEM NO. MS-MH04
 Length: 13cm Width: 7cm Slot size: \varnothing 2.5cm





Foam Cannon Wall Mount & Nozzle Holder

ITEM NO. MS-CH10
 Size: 39 (L) x 14(W) x 3.5(H)cm Weight: 1.16kg
 Material: High Quality Metal with Paint
 Included: 2PCS 1/4" Female Quick Connector
 1PC 1/4" Male Quick Connector



Spray Bottle Racks-16oz/32oz

ITEM NO. MS-CH02
 Length: 540mm
 Width: 190mm
 Height: 180mm
 Slot size: 85mm
 Material: Iron
 Useful: 16OZ/ 32OZ Bottle Only

Spray Bottle Racks-16oz

ITEM NO. MS-CH02B
 Length: 464mm
 Width: 100mm
 Height: 170mm
 Slot size: 70mm
 Material: Iron
 Useful: 16OZ Bottle Only

Ceramic Coating Holder

ITEM NO. MS-CH03
 Length: 200 mm
 Width: 55mm
 Height: 30 + 20 mm
 Slot size: 42mm
 Material: Iron



Snow Master Foam Cannon Holder



Snow Master Foam Cannon Holder

ITEM NO. MS-CH04
 Length: 120 mm
 Width: 120mm
 Height: 175mm
 Material: Iron



Foam Cannon Bucket Mount

Foam Cannon Bucket Mount

ITEM NO. MS-CH05
 Length: 60 mm
 Width: 90.7mm
 Height: 85.82mm
 Weight: 0.23kg
 Material: Iron



Customized design is available

Compound Holder

ITEM NO. MS-CH01
 Length: 460 mm
 Width: 100mm
 Height: 80 + 30 mm
 Slot size: 85mm
 Material: Iron



Premium Wall Mount Foam Cannon And Tornador Holder

ITEM NO. MS-CH09
 Size: 8.27" Tall x 5.91" Wide x 6.3" Deep
 Material: Iron
 Useful:
 The bottle opening is 5.27" - so any bottle with a diameter less than 5.27" and a sturdy flat base will work.



Foam Pads Holder

ITEM NO. MS-FPH-80
 Suitable for 3" Foam pad
 High: 350mm Dia: 105mm Material: Iron

ITEM NO. MS-FPH-160
 Suitable for 5" Foam pad
 High: 350mm Dia: 160mm Material: Iron

ITEM NO. MS-FPH-180
 Suitable for 6" Foam pad
 High: 355mm Dia: 180mm Material: Iron



ITEM NO. MS-MH09
 Size: 18 x 8.3 x 22cm
 Material: Steel

Universal Wall Mount Hanger

ITEM NO. MS-CH06
 Size: 8 x 2.5cm
 Weight: 0.047kg
 Material: Iron



Pressure Washer Gun & Snow Foam Lance Wall Mount

ITEM NO. MS-MH08 Size: 36 x 23 x 4.7cm
 Material: Steel



Glove Box Holder

ITEM NO. MS-GBH01
 Length: 14cm Width: 9cm
 Height: 25cm Material: Iron

- Made of high-quality resistant steel
- Powder coating finish to provide additional protection against oxidation.
- Designed to fit most sized boxes of gloves.
- Keep your gloves right where you need them.
- Easy wall mounting installation



High Pressure Spray Gun Holder

ITEM NO. MS-CH07
 Size: 80x150x50.5mm Thickness: 20mm
 Weight: 0.3kg Material: Iron

- Compatible with Maxshine High Pressure Water Gun.
- Easy installation, uses only 2 screws.
- Made of high-quality steel materials.
- Not Included: High Pressure Spray Gun.



Phone & Headphone Holder

ITEM NO. MS-CH08
 Size: 120.9x 88.5x 217.3cm Weight: 0.3kg
 Withstand Weight: 3.3lbs Material: Iron

- Mounts to Wall w/ Screws Provided.
- Holds Most Phone Models and Headphone Sizes.
- High Quality Steel Construction.
- Withstand Weight of 3.3 lbs.



Stainless steel car Mat Hanger-Single

ITEM NO. MS-MCH01
 Size: 11.81x1.93x2.52 in (30x4.9x6.4 cm)
 Weight: 0.42 kg
 Material: Stainless Steel



Iron Bucket Dolly

ITEM NO. MS-BD02
 Quality Special Paint Processing ,
 No Rust,40x40cm with wheels,
 2 holes for shampoo, 5 holes for brushes



Buckets Dolly

ITEM NO. MS-BD01
 Material: Heavy duty molded plastic,
 Holds 3.5 to 7 gallon buckets